

Frames & Gallery Frames Art Supplies

catalogue export 2023/2024

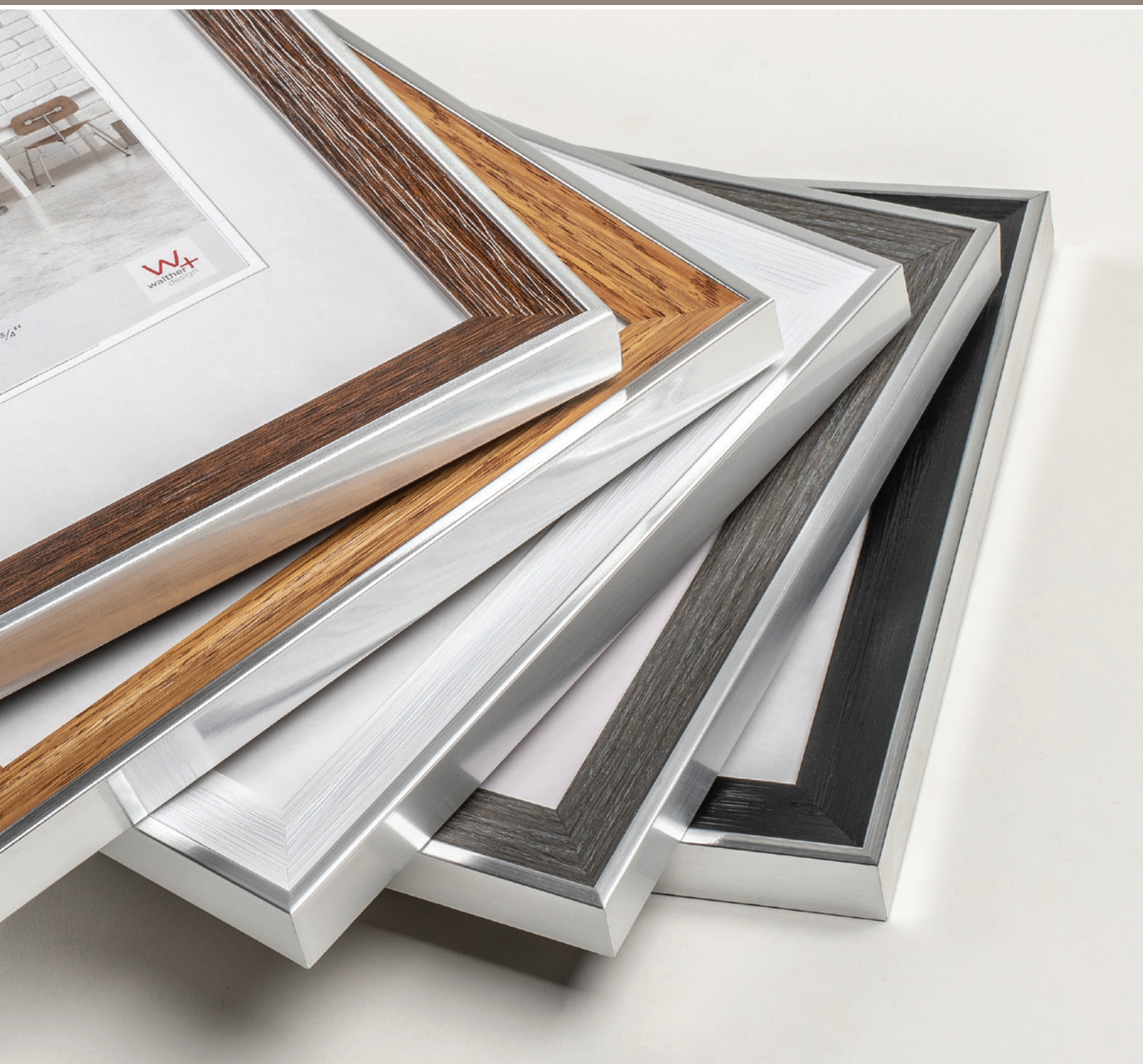

walther design Service - Promptly and Reliable

- Hotline + 49 2157 8186-0
- Fax + 49 2157 8186-50
- Email service@waltherdesign.de
- Website www.waltherdesign.de/en

· Address

walther design GmbH & Co. KG
Post Box 25 27 | 41312 Nettetal | Germany
Herrenpfad-Süd 26 | 41334 Nettetal | Germany



walther design Online Shop | www.waltherdesign.de/en

You can place orders at any time at www.waltherdesign.de/en
In addition to comprehensive product line and price informations, we always have attractive special offers going on for you.



- protected access for commercial partners only
- comprehensive presentation of product line
- current promotions and offers
- innovations and remaining stock
- option to order online
- catalogue and advertising materials download
- www.waltherdesign.de/en



walther design - The Company

walther design GmbH & Co. KG is a leading provider in Europe for table top frames, picture frames and photo albums. Throughout its more than 90 years existence, the company has always put great emphasis on the quality of its products.

The company headquarters is located in Nettetal, 60 km west from Düsseldorf, near the border with the Netherlands. From this location, goods are dispatched to more than 3,000 customers in over 50 countries.

Over 90 years of experience, 60 motivated employees and a company strategy directed towards continuous improvement makes us a great partner for you.

walther design GmbH & Co. KG stands for clear orientation towards the customer's needs and superior quality in service. In consultation with our commercial partners, we are constantly developing our product lines to incorporate current design and colour trends into our products.

In addition to future-oriented product policies, the expansions and optimisation made to walther design presentation and sales aids represents a second, further success factor.



Customer Service Office

High level of service with quick response time and personal contact.





Logistics Centre & Field Service The Service and Quality Advantage

Within striking distance to the Rhine-Ruhr conurbation and the Netherlands, walther design's Nettetal headquarters provides the company with over 14,000 m² office and storage space.

Entirely comprehensive field service and the modern logistics centre, with 17,500 pallet spaces, are our important success factors.



ISO 9001 Certification

In 2013, our embarking to a modern yet traditionally anchored future was emphasized by an optimization of processes by acquiring the ISO 9001 certification. The certificate was awarded by TÜV Rheinland in 2013, and reconfirmed every year since then.

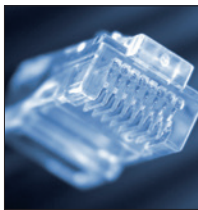

Pick-by-voice

Voice-operated ordering for increased efficiency and productivity while simultaneously reducing the margin of error.

EDI

EDI connection (Electronic Data Interchange) ensures customer communication oriented towards the future and the rationalisation of standardised business processes (order processing and invoicing).

We're at your service.

Your walther design Contact

Field Service	Telephone	Internal Service	Telephone
Mr Volker Francke	+49 151 44349872	Mrs Jennifer Basler	+49 2157 8186-481
Mrs Marianne Nutz	+49 151 72501487	Mrs Carina Beyer	+49 2157 8186-419
Mr Christian Schmieding	+49 175 3560147	Mrs Tanja Herdzik	+49 2157 8186-413
Mr Jens Töbermann	+49 178 2779060	Mrs Andrea Reuschenbach	+49 2157 8186-412
Mr Holger Voigtländer	+49 170 5481534	Mrs Miriam Rütten	+49 2157 8186-418
		Mrs Simone Settels	+49 2157 8186-415
		Mrs Jessica Tönnishoff	+49 2157 8186-482

Your walther design Contact for the Key Accounts

Mrs Sabrina Littig	+49 2157 8186-407	Mrs Claudia Stoffers	+49 2157 8186-409
Mr Dirk Stappen	+49 2157 8186-410	Mrs Sabine Wöll	+49 2157 8186-411

walther design – Simply the best

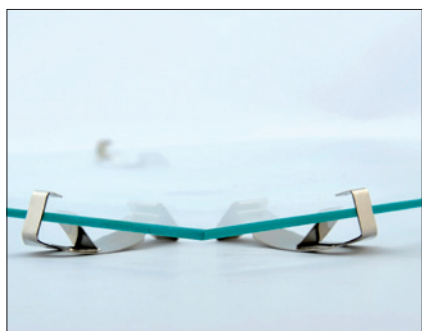

Glass

Our product line of frames uses only cut washed glass, anti-reflective or artificial glass.

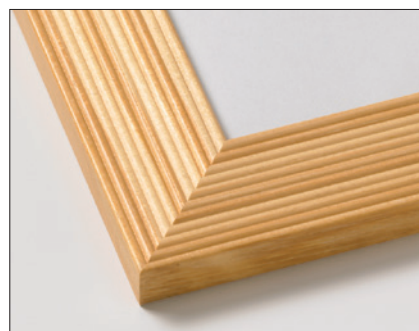

Mitres

The frame woodwork is distinguished by the exact and extremely durable mitre, largely achieved using glue and additional metal connectors.



Frame Formats and Inserts

On the following pages, you will find the specification frame sizes. This means the visible image size, or the glass format. Most of our frames have pre-stamped, acid-free mount inserts. The appropriate matching cut-out you will find under the specification picture format. On request, we also provide you with the exact dimensions of the respective frames.

All walther gallery frames and some of the single frames are furthermore equipped with bevelled mounts.



Sealing System

Most of our back panels in the standard product line are equipped with stable, easy to use turning clips which make it extremely easy to insert and replace photos.

Design picture frames are provided with flexpins.

Backing

The frames are equipped with MDF backings which are formaldehyde-free and continuously being tested by independent institutes.



Hanging

Our frames are, with a few exceptions, equipped with easels for landscape and portrait hanging up to format 21 x 30 cm / 8" x 11 3/4", and additionally have metal suspension devices in two sizes (depends on the frame size). We also deliver many of our frames with a high-quality gallery hanging system, starting from size 40 x 50 cm / 11 3/4" x 15 3/4", which makes hanging the frame significantly easier.



Edge Protection

Our frames are protected, even against particularly demanding transport, by walther cardboard edge protectors made from the highest quality of cardboard, starting from a format of 20 x 30 cm / 8" x 11 3/4", and extremely tear-resistant shrink-wrapped foil. All clip frame sizes are delivered with tear-resistant full cardboard packaging.



Mounts

The finely tailored walther mount programm is the ideal complement, because bevelled mount enhances the image even further. We offer precise diagonal cuts with environmentally friendly quality, within an acid-free and white core.

Our mounts are offered with precise diagonal cuts and are of an environmental friendly quality. They are acid-free and have a white core.



Parts of a picture frame

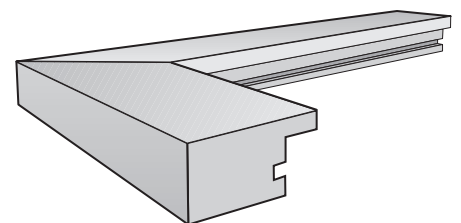
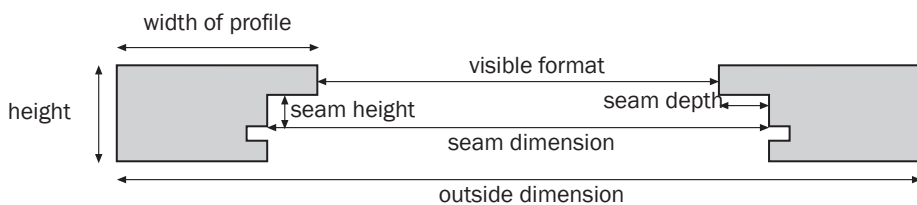
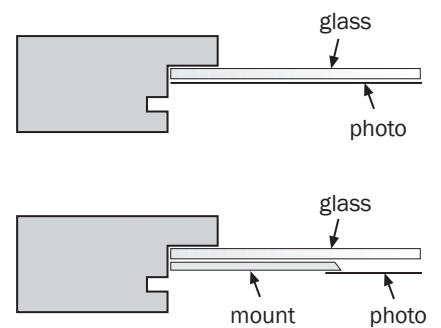
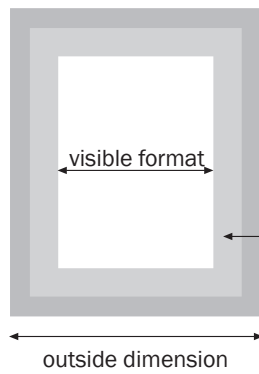
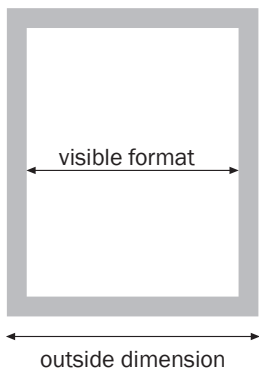

Plastic Frames



NEW LIFESTYLE profile KV **NEW COLOURS!**

- **rectangular plastic profile** slightly rounded, available as single frames
- **glass** clear glass washed • **profile change** larger profile from size 30 x 45 cm / 11 ¾" x 17 ¾"
- **easel** up to size 20 x 25 cm / 8" x 10" • **** KV 712** 12 units in a display
- **certificate inlay** size 21 x 29,7 cm / DIN A4 / 8 ¼" x 11 ¾"
- **B** black | **D*** steel | **G*** gold | **I** yellow | **J*** bronze | **K** grass-green | **L** blue | **Q** pink | **R** red | **S*** silver | **T** grey | **U** turquoise
W white | **X*** taupe • *** foiled surface**

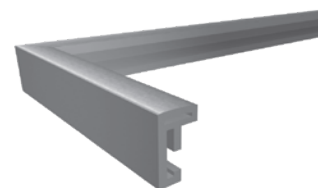
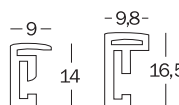

article no.	frame format cm	frame format inch	picture format cm	picture format inch	unit	colours
KV 712 __	7 x 10	2,8 x 3,9	7 x 10	2,8 x 3,9	12	S
KV 015 __	10 x 15	3,9 x 5,9	7 x 10	2,8 x 3,9	1	B D G J K L Q R S T U W
KV 318 __	13 x 18	5,1 x 7,1	9 x 13	3,5 x 5,1	1	B D G J L Q R S T U W
KV 520 __	15 x 20	5,9 x 7,9	10 x 15	3,9 x 5,9	1	B D G J L Q R S T U W
KV 824 __	18 x 24	7,1 x 9,4	13 x 18	5,1 x 7,1	1	B D G I J L Q R S T U W X
KV 025 __	20 x 25	7,9 x 9,8	13 x 18	5,1 x 7,1	1	B D G J L R S W
KV 030 __	20 x 30	7,9 x 11,8	13 x 18	5,1 x 7,1	1	B D G J L Q R S T U W X
KV 130 __	21 x 29,7	8,3 x 11,7	DIN A4		1	B D G J L Q R S T U W
KV 430 __	24 x 30	9,4 x 11,8	15 x 20	5,9 x 7,9	1	B D G J L R S W
KV 835 __	28 x 35	11 x 13,8	18 x 24	7,1 x 9,4	1	B D G J L R S W
KV 342 __	29,7 x 42	11,7 x 16,5	18 x 24	7,1 x 9,4	1	B D G S W
KV 040 __	30 x 40	11,8 x 15,7	20 x 30	7,9 x 11,8	1	B D G J K L Q R S T U W
KV 045 __	30 x 45	11,8 x 17,7	20 x 30	7,9 x 11,8	1	B D G I J K L Q R S T U W X
KV 050 __	40 x 50	15,7 x 19,7	30 x 40	11,8 x 15,7	1	B D G I J L Q R S T U W X
KV 460 __	40 x 60	15,7 x 23,6	30 x 45	11,8 x 17,7	1	B D G J L R S W
KV 426 __	42x59,4	16,5 x 23,4	DIN A2		1	B D G S W
KV 060 __	50 x 60	19,7 x 23,6	40 x 50	15,7 x 19,7	1	B D G J L R S W
KV 070 __	50 x 70	19,7 x 27,6	40 x 60	15,7 x 23,6	1	B D G J L Q R S T U W X
KV 080 __	60 x 80	23,6 x 31,5	50 x 70	19,7 x 27,6	1	B D G J L R S W
KV 684 __	59,4x84	23,4 x 33,1	DIN A1		1	B D G S W
KV 090 __	60 x 90	23,6 x 35,4	42 x 59,4	16,5 x 23,4	1	B D G J L R S W
KV 691 __	61 x 91,5	24 x 36			1	B D G S W
KV 100 __	70 x 100	27,6 x 39,4	50 x 70	19,7 x 27,6	1	B D G J L R S W
KV 010 __	10 x 10	3,9 x 3,9	7 x 7	2,8 x 2,8	1	B D G S W
KV 313 __	13 X 13	5,1 x 5,1	9 X 9	3,5 x 3,5	1	B D G S W
KV 150 __	15 X 15	5,9 x 5,9	10 X 10	3,9 x 3,9	1	B D G S W
KV 220 __	20 x 20	7,9 x 7,9	15 x 15	5,9 x 5,9	1	B D G S W
KV 330 __	30 x 30	11,8 x 11,8	18 x 18	7,1 x 7,1	1	B D G S W
KV 113 __	10 x 13	3,9 x 5,1			1	B D G S W
KV 118 __	10 x 18	3,9 x 7,1			1	B D G S W

Plastic Frames

NEW LIFESTYLE profile KV

- **rectangular plastic profile** slightly rounded, available as single frames and gallery frames
- **glass** clear glass washed • **profile change** larger profile from size 30 x 45 cm / 11 ¾" x 17 ¾"
- **easel** up to size 20 x 25 cm / 8" x 10" • **with bevelled mount**
- **B** black | **D*** steel | **G*** gold | **J*** bronze | **L** blue | **R** red | **S*** silver | **W** white • * **foiled surface**

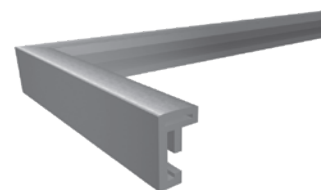

article no.	frame format cm	frame format inch	picture format cm	picture format inch	unit	colours
KV 315 __	23 x 46	9,1 x 18,1	3 x 10x15		1	B D G J L R S W
KV 338 __	25,4 x 50,7	10 x 20	3 x 13x18		1	B D G J L R S W
KV 320 __	27,8 x 58,2	10,9 x 22,9	3 x 15x20		1	B D G J L R S W
KV 515 __	23 x 72	9,1 x 28,3	5 x 10x15		1	B D G J L R S W

NEW! NEW LIFESTYLE profile K VX with artificial glass

- **rectangular plastic profile** slightly rounded, available as single frames
- **glass** artificial glass • **profile change** larger profile from size 30 x 45 cm / 11 ¾" x 17 ¾"
- **certificate inlay** size 21 x 29,7 cm / DIN A4 / 8 ¼" x 11 ¾"
- **B** black | **D*** steel | **G*** gold | **S*** silver | **W** white • * **foiled surface**

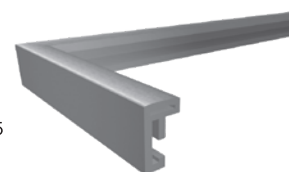
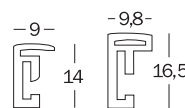
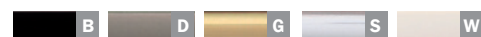

article no.	frame format cm	frame format inch	picture format cm	picture format inch	unit	colours
K VX 030 __	20 x 30	7,9 x 11,9	13 x 18	5 x 7	1	B D G S W
K VX 130 __	21 x 29,7	8,3 x 11,7	DIN A4		1	B D G S W
K VX 040 __	30 x 40	11,8 x 15,7	20 x 30	8 x 11,7	1	B D G S W
K VX 342 __	29,7 x 42	11,7 x 16,5	DIN A3		1	B D G S W
K VX 050 __	40 x 50	15,7 x 19,7	30 x 40	11,8 x 15,7	1	B D G S W
K VX 460 __	40 x 60	15,7 x 23,6	30 x 45	11,8 x 17,7	1	B D G S W
K VX 426 __	42x59,4	16,5 x 23,4	DIN A2		1	B D G S W
K VX 060 __	50 x 60	19,7 x 23,6	40 x 50	15,7 x 19,7	1	B D G S W
K VX 070 __	50 x 70	19,7 x 27,6	40 x 60	15,7 x 23,6	1	B D G S W
K VX 080 __	60 x 80	23,6 x 31,5	50 x 70	19,7 x 27,6	1	B D G S W
K VX 684 __	59,4x84	23,4 x 33,1	DIN A1		1	B D G S W
K VX 090 __	60 x 90	23,6 x 35,4	42 x 59,4	poster format	1	B D G S W
K VX 691 __	61 x 91,5	24 x 36		poster format	1	B D G S W
K VX 100 __	70 x 100	27,6 x 39,4	50 x 70	19,7 x 27,6	1	B D G S W

Plastic Frames



TRENDSTYLE profile KP

- **half-round plastic profile** available as single frames
- **glass** clear glass washed • **easel** up to size 20 x 30 cm / 8" x 11 3/4"
- **B** black | **D*** steel | **F*** silver/black | **G*** gold metallic | **M** indigo blue
- **S*** silver metallic | **T*** anthracite/black | **W*** white * **foiled surface**

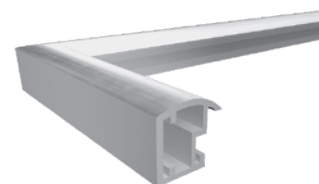
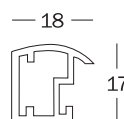
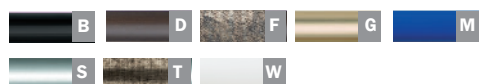

article no.	frame format cm	frame format inch	picture format cm	picture format inch	unit	colours						
KP 015 __	10 x 15	3,9 x 5,9	7 x 10	2,8 x 3,9	1	B	D	G	S	W		
KP 318 __	13 x 18	5,1 x 7,1	9 x 13	3,5 x 5,1	1	B	D	F	G	S	T	W
KP 520 __	15 x 20	5,9 x 7,9	10 x 15	3,9 x 5,9	1	B	D	G	M	S	W	
KP 824 __	18 x 24	7,1 x 9,4	13 x 18	5,1 x 7,1	1	B	D	G	S	W		
KP 030 __	20 x 30	7,9 x 11,8	13 x 18	5,1 x 7,1	1	B	D	G	S	W		
KP 130 __	21 x 29,7	8,3 x 11,7	13 x 18	5,1 x 7,1	1	B	D	G	S	W		
KP 430 __	24 x 30	9,4 x 11,8	15 x 20	5,9 x 7,9	1	B	D	G	S	W		
KP 040 __	30 x 40	11,8 x 15,7	20 x 30	7,9 x 11,8	1	B	D	G	S	T	W	
KP 045 __	30 x 45	11,8 x 17,7	20 x 30	7,9 x 11,8	1	B	D	G	S	W		
KP 050 __	40 x 50	15,7 x 19,7	30 x 40	11,8 x 15,7	1	B	D	G	S	W		
KP 460 __	40 x 60	15,7 x 23,6	30 x 45	11,8 x 17,7	1	B	D	G	S	W		
KP 060 __	50 x 60	19,7 x 23,6	40 x 50	15,7 x 19,7	1	B	D	G	S	W		
KP 070 __	50 x 70	19,7 x 27,6	40 x 60	15,7 x 23,6	1	B	D	G	S	W		
KP 080 __	60 x 80	23,6 x 31,5	50 x 70	19,7 x 27,6	1	B	D	G	S	W		
KP 100 __	70 x 100	27,6 x 39,4	50 x 70	19,7 x 27,6	1	B	D	G	S	W		

Plastic Frames



GALERIA profile K

- **half-round plastic profile** available as single frames, special sizes, panoramic and gallery frames
- **glass** clear glass washed • **profile change** larger profile from size 30x45 cm 11 3/4" x 17 3/4"
- **easel** up to size 21 x 30 cm / 8 1/4" x 11 3/4" • **gallery hanging system** from size 40 x 50 cm / 15 3/4" x 19 3/4"
- **certificate inlay** size 21 x 29,7 cm / DIN A4 / 8 1/4" x 11 3/4"
- **B** black | **D*** steel | **G*** gold metallic | **J*** copper | **L** blue | **R** red | **S*** silver metallic | **W*** white • * foiled surface

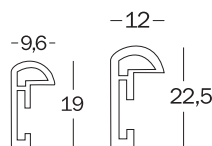

article no.	frame format cm	frame format inch	picture format cm	picture format inch	unit	colours
K__913 H	9 x 13	3,5 x 5,1	5 x 7	2 x 2,8	1	B D G S W
K__015 H	10 x 15	3,9 x 5,9	7 x 10	2,8 x 3,9	1	B D G R S W
K__318 H	13 x 18	5,1 x 7,1	9 x 13	3,5 x 5,1	1	B D G J R S W
K__520 H	15 x 20	5,9 x 7,9	10 x 15	3,9 x 5,9	1	B D G S W
K__824 H	18 x 24	7,1 x 9,4	13 x 18	5,1 x 7,1	1	B D G S W
K__028 H	20 x 28	7,9 x 11	13 x 18	5,1 x 7,1	1	B G S W
K__030 H	20 x 30	7,9 x 11,8	13 x 18	5,1 x 7,1	1	B D G S W
K__130 H	21 x 29,7	8,3 x 11,7	DIN A4		1	B D G S W
K__430 H	24 x 30	9,4 x 11,8	15 x 20	5,9 x 7,9	1	B D G S W
K__835 H	28 x 35	11 x 13,8	18 x 24	7,1 x 9,4	1	B D G S W
K__040 H	30 x 40	11,8 x 15,7	20 x 30	7,9 x 11,8	1	B D G S W
K__342 H	29,7 x 42	11,7 x 16,5	DIN A3		1	B S
K__045 H	30 x 45	11,8 x 17,7	20 x 30	7,9 x 11,8	1	B D G J S W
K__050 H	40 x 50	15,7 x 19,7	30 x 40	11,8 x 15,7	1	B D G S W
K__460 H	40 x 60	15,7 x 23,6	30 x 45	11,8 x 17,7	1	B D G S W
K__060 H	50 x 60	19,7 x 23,6	40 x 50	15,7 x 19,7	1	B G S W
K__070 H	50 x 70	19,7 x 27,6	40 x 60	15,7 x 23,6	1	B D G L S W
K__075 H	50 x 75	19,7 x 29,5	40 x 50	15,7 x 19,7	1	B S
K__080 H	60 x 80	23,6 x 31,5	50 x 70	19,7 x 27,6	1	B D G L R S W
K__090 H	60 x 90	23,6 x 35,4	DIN A2		1	B G S W
K__100 H	70 x 100	27,6 x 39,4	50 x 70	19,7 x 27,6	1	B D G L S W
K__220 H	20 x 20	7,9 x 7,9	15 x 15	5,9 x 5,9	1	B S W
K__330 H	30 x 30	11,8 x 11,8	18 x 18	7,1 x 7,1	1	B S W
K__440 H	40 x 40	15,7 x 15,7	28 x 28	11 x 11	1	B S W
K__550 H	50 x 50	19,7 x 19,7	35 x 35	13,8 x 13,8	1	B D S W
K__660 H	60 x 60	23,6 x 23,6	40 x 40	15,7 x 15,7	1	B S W
K__390 H	30 x 90	11,8 x 35,4	30 x 90	11,8 x 35,4	1	B S
K__400 H	40 x 100	15,7 x 39,4	40 x 100	15,7 x 39,4	1	B S
K__500 H	50 x 100	19,7 x 39,4	50 x 100	19,7 x 39,4	1	B S

Plastic Frames



GALERIA profile K

- **half-round plastic profile** available as single frames, special sizes, panoramic and gallery frames
- **glass** clear glass washed • **profile change** larger profile from size 30 x 45 cm 11 3/4" x 17 3/4"
- **with bevelled mount**
- **B** black | **S*** silver metallic | **W*** white • * **foiled surface**

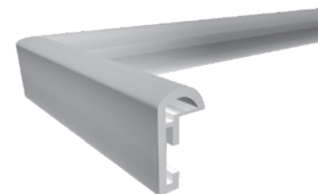
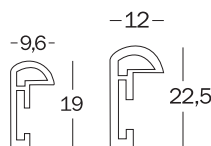

article no.	frame format cm	frame format inch	picture format cm	picture format inch	unit	colours		
K_ 315 S	23 x 46	9,1 x 18,1	3 x 10x15	3x 4,1 x 5,9	1	B	S	W
K_ 338 S	25,4 x 50,7	10 x 20	3 x 13x18	3x 5,1 x 7,1	1	B	S	W
K_ 515 H	23 x 72	9,1 x 28,3	5 x 10x15	5x 4,1 x 5,9	1	B	S	



STEEL STYLE profile ES

- **small plastic desk profile**, available as single frames
- **glass** clear glass washed • **easel** up to size 20 x 30 cm / 8" x 11 3/4"
- **with bevelled mount** • **gallery hanging system** from size 40 x 50 cm / 15 3/4" x 19 3/4"
- **B** black | **D*** steel | **G*** gold | **S*** silver | **W*** white • * **foiled surface**



article no.	frame format cm	frame format inch	picture format cm	picture format inch	unit	colours				
ES 015 _	10,5 x 15	4,1 x 5,9	7 x 10	2,8 x 3,9	1	B	D	G	S	W
ES 318 _	13 x 18	5,1 x 7,1	9 x 13	3,5 x 5,1	1	B	D	G	S	W
ES 520 _	15 x 20	5,9 x 7,9	10 x 15	3,9 x 5,9	1	B	D	G	S	W
ES 824 _	18 x 24	7,1 x 9,4	13 x 18	5,1 x 7,1	1	B	D	G	S	W
ES 030 _	20 x 30	7,9 x 11,8	15 x 20	5,9 x 7,9	1	B	D	G	S	W
ES 130 _	21 x 29,7	8,3 x 11,7	DIN A4		1	B	D	G	S	W
ES 040 _	30 x 40	11,8 x 15,7	20 x 30	7,9 x 11,8	1	B	D	G	S	W
ES 045 _	30 x 45	11,8 x 17,7	20 x 30	7,9 x 11,8	1	B	D	G	S	W
ES 050 _	40 x 50	15,7 x 19,7	30 x 40	11,8 x 15,7	1	B	D	G	S	W
ES 460 _	40 x 60	15,7 x 23,6	30 x 45	11,8 x 17,7	1	B	D	G	S	W
ES 060 _	50 x 60	19,7 x 23,6	40 x 50	15,7 x 19,7	1	B	D	G	S	W
ES 070 _	50 x 70	19,7 x 27,6	40 x 60	15,7 x 23,6	1	B	D	G	S	W
ES 080 _	60 x 80	23,6 x 31,5	50 x 70	19,7 x 27,6	1	B	D	G	S	W
ES 220 _	20 x 20	7,9 x 7,9	15 x 15	5,9 x 5,9	1	B		G	S	W
ES 220 _	20 x 20	7,9 x 7,9	13 x 13	5,1 x 5,1	1		D			
ES 330 _	30 x 30	11,8 x 11,8	18 x 18	7,1 x 7,1	1	B	D	G	S	W
ES 440 _	40 x 40	15,7 x 15,7	28 x 28	11 x 11	1	B	D	G	S	W

Plastic Frames



NEW! DESIRE profile DEX with artificial glass

- **small plastic desk profile sloping inwards**, available as single frames
- **glass** artificial glass • **easel** up to size 20 x 30 cm / 8" x 11 3/4"
- **profile change** larger profile from size 30 x 45 cm 11 3/4" x 17 3/4"
- **B** black | **G** gold | **S** silver | **W** white

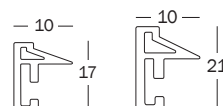

article no.	frame format cm	frame format inch	picture format cm	picture format inch	unit	colours			
DEX 015 __	10 x 15	3,9 x 5,9	7 x 10	2,8 x 3,9	1	B	G	S	W
DEX 318 __	13 x 18	5,1 x 7,1	9 x 13	3,5 x 5,1	1	B	G	S	W
DEX 520 __	15 x 20	5,9 x 7,9	10 x 15	3,9 x 5,9	1	B	G	S	W
DEX 030 __	20 x 30	7,9 x 11,8	15 x 20	5,9 x 7,9	1	B	G	S	W
DEX 040 __	30 x 40	11,8 x 15,7	20 x 30	7,9 x 11,8	1	B	G	S	W
DEX 050 __	40 x 50	15,7 x 19,7	30 x 40	11,8 x 15,7	1	B	G	S	W
DEX 460 __	40 x 60	15,7 x 23,6	30 x 45	11,8 x 17,7	1	B	G	S	W
DEX 070 __	50 x 70	19,7 x 27,6	40 x 60	15,7 x 23,6	1	B	G	S	W

Design Frames



CONSTRUCTION profile JK

- **rectangular polystyrene profile** with aluminium look, available as single frames
- **glass** clear glass washed • **foiled surface** • **easel** up to size 21 x 30 cm / 6" x 8"
- **certificate inlay** size 21 x 29,7 cm / DIN A4 / 8 ¼" x 11 ¾"
- **B** black | **D** steel | **S** silver | **W** white

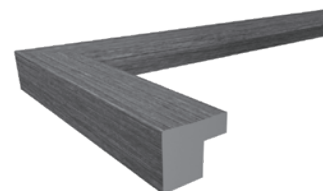
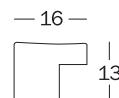

article no.	frame format cm	frame format inch	picture format cm	picture format inch	unit	colours
JK 015 __	10 x 15	3,9 x 5,9	7 x 10	2,8 x 3,9	1	B D S W
JK 318 __	13 x 18	5,1 x 7,1	9 x 13	3,5 x 5,1	1	B D S W
JK 520 __	15 x 20	5,9 x 7,9	10 x 15	3,9 x 5,9	1	B D S W
JK 824 __	18 x 24	7,1 x 9,4	13 x 18	5,1 x 7,1	1	B D S W
JK 130 __	21 x 29,7	8,3 x 11,7	13 x 18	5,1 x 7,1	1	B D S W
JK 040 __	30 x 40	11,8 x 15,7	20 x 30	7,9 x 11,8	1	B D S W



NEW! BEYOND profile JI

- **rectangular wide polystyrene profile** with silver inner edge, available as single frames
- **glass** clear glass washed • **foiled surface**
- **C** champagner gold | **D** steel | **S** silver

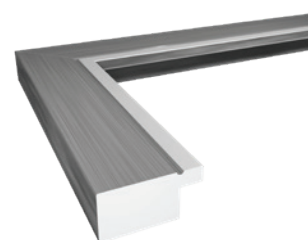

article no.	frame format cm	frame format inch	picture format cm	picture format inch	unit	colours
JJ 342 __	29,7 x 42	11,7 x 16,5	DIN A3		1	D S W



NEW! VENICE profile JL

- **shiny, wide, round polystyrene profile** sloping inwards, available as single frames
- **glass** clear glass washed • **foiled surface** • **easel** up to size 20 x 30 cm / 8" x 11 ¾"
- **D** steel | **G** gold | **J** bronze | **S** silver

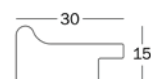

article no.	frame format cm	frame format inch	picture format cm	picture format inch	unit	colours
JL 318 __	13 x 18	5,1 x 7,1	9 x 13	3,5 x 5,1	1	D G J S
JL 520 __	15 x 20	5,9 x 7,9	10 x 15	3,9 x 5,9	1	D G J S
JL 030 __	20 x 30	7,9 x 11,8	15 x 20	5,9 x 7,9	1	D G J S
JL 040 __	30 x 40	11,8 x 15,7	20 x 30	7,9 x 11,8	1	D G J S
JL 050 __	40 x 50	15,7 x 19,7	30 x 40	11,8 x 15,7	1	D G J S

Design Frames



BOHEMIAN profile EN

- **polystyrene profile sloping inwards** available as single frames • **foiled surface**
- **glass** clear glass washed • **easel** up to size 20 x 30 cm / 6" x 8"
- **B** black | **C** cream | **D** grey | **N** walnut | **P** beech

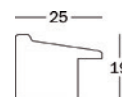

article no.	frame format cm	frame format inch	picture format cm	picture format inch	unit	colours
EN 015 __	10 x 15	3,9 x 5,9	7 x 10	2,8 x 3,9	1	C D N P
EN 318 __	13 x 18	5,1 x 7,1	9 x 13	3,5 x 5,1	1	C D N P
EN 520 __	15 x 20	5,9 x 7,9	10 x 15	3,9 x 5,9	1	C D P
EN 824 __	18 x 24	7,1 x 9,4	13 x 18	5,1 x 7,1	5	C D N P
EN 030 __	20 x 30	7,9 x 11,8	15 x 20	5,9 x 7,9	1	C D N P
EN 040 __	30 x 40	11,8 x 15,7	20 x 30	7,9 x 11,8	1	C D N P
EN 050 __	40 x 50	15,7 x 19,7	30 x 40	11,8 x 15,7	1	B C D N P
EN 070 __	50 x 70	19,7 x 27,6	40 x 60	15,7 x 23,6	1	B C D N P



SMELL profile JD

- **fluted polystyrene profile** with high gloss surface in burl look and gold inner and outer edge, available as single frames
- **glass** clear glass washed • **easel** up to size 21 x 30 cm / 6" x 8" • **foiled surface**
- **certificate inlay** size 21 x 29,7 cm / DIN A4 / 8 ¼" x 11 ¾"
- **N** walnut gold

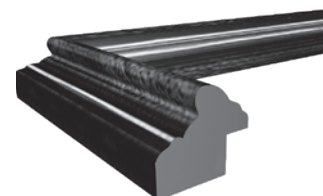
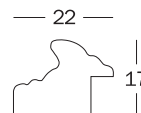

article no.	frame format cm	frame format inch	picture format cm	picture format inch	unit	colours
JD 015 __	10 x 15	3,9 x 5,9	7 x 10	2,8 x 3,9	5	N
JD 318 __	13 x 18	5,1 x 7,1	9 x 13	3,5 x 5,1	5	N
JD 520 __	15 x 20	5,9 x 7,9	10 x 15	3,9 x 5,9	5	N
JD 130 __	21 x 29,7	8,3 x 11,7	13 x 18	5,1 x 7,1	5	N
JD 040 __	30 x 40	11,8 x 15,7	20 x 30	7,9 x 11,8	2	N

Design Frames



LOUNGE profile JA

- **fluted polystyrene profile** available as single frames • **foiled surface**
- **glass** clear glass washed • **easel** up to size 21 x 30 cm / 8 ¼" x 11 ¾"
- **certificate inlay** size 21 x 29,7 cm / DIN A4 / 8 ¼" x 11 ¾"
- **D** steel | **G** gold | **S** silver

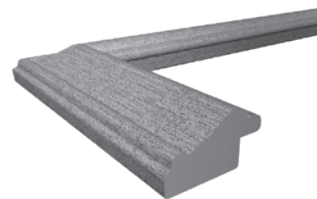

article no.	frame format cm	frame format inch	picture format cm	picture format inch	unit	colours
JA 015 __	10 x 15	3,9 x 5,9	7 x 10	2,8 x 3,9	5	D G S
JA 318 __	13 x 18	5,1 x 7,1	9 x 13	3,5 x 5,1	5	D G S
JA 520 __	15 x 20	5,9 x 7,9	10 x 15	3,9 x 5,9	5	D G S
JA 030 __	20 x 30	7,9 x 11,8	13 x 18	5,1 x 7,1	5	D G S
JA 130 __	21 x 29,7	8,3 x 11,7	13 x 18	5,1 x 7,1	5	D G S
JA 040 __	30 x 40	11,8 x 15,7	20 x 30	7,9 x 11,8	2	D G S
JA 050 __	40 x 50	15,7 x 19,7	30 x 40	11,8 x 15,7	2	D G S



CHALET profile EL

- **polystyrene profile sloping inwards**, available as single frames
- **glass** clear glass washed • **foiled surface** • **with bevelled mount**
- **easel** up to size 20 x 30 cm / 8" x 11 ¾"
- **B** black | **H** nature | **L** blue | **R** red | **W** white

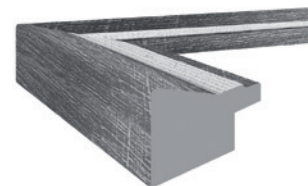
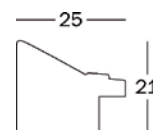

article no.	frame format cm	frame format inch	picture format cm	picture format inch	unit	colours
EL 015 __	10 x 15	3,9 x 5,9	7 x 10	2,8 x 3,9	1	B H L W
EL 318 __	13 x 18	5,1 x 7,1	9 x 13	3,5 x 5,1	1	B H L W
EL 520 __	15 x 20	5,9 x 7,9	10 x 15	3,9 x 5,9	1	B H L W
EL 824 __	18 x 24	7,1 x 9,4	13 x 18	5,1 x 7,1	1	B H L W
EL 030 __	20 x 30	7,9 x 11,8	15 x 20	5,9 x 7,9	1	B H L W
EL 430 __	24 x 30	9,4 x 11,8	15 x 20	5,9 x 7,9	1	H R W
EL 040 __	30 x 40	11,8 x 15,7	20 x 30	7,9 x 11,8	1	B H L W
EL 050 __	40 x 50	15,7 x 19,7	30 x 40	11,8 x 15,7	1	B H L R W
EL 460 __	40 x 60	15,7 x 23,6	30 x 45	11,8 x 17,7	1	B H L R W
EL 070 __	50 x 70	19,7 x 27,6	40 x 60	15,7 x 23,6	1	B H L R W

Design Frames



METRO profile LO

- **rectangular polystyrene profile** with silver inner edge, available as single frames
- **glass** clear glass washed • **foiled surface**
- **easel** up to size 20 x 30 cm / 8" x 11 3/4"
- **B** black | **D** steel | **S** silver | **W** white

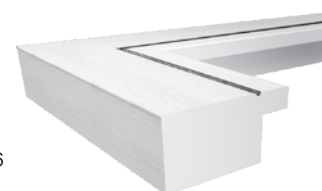
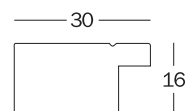

article no.	frame format cm	frame format inch	picture format cm	picture format inch	unit	colours			
LO 015 __	10 x 15	3,9 x 5,9	7 x 10	2,8 x 3,9	1	B	D	S	W
LO 318 __	13 x 18	5,1 x 7,1	9 x 13	3,5 x 5,1	1	B	D	S	W
LO 520 __	15 x 20	5,9 x 7,9	10 x 15	3,9 x 5,9	1				W

Wooden Frames



GRADO profile HI

- **rectangular wooden profile** with creased surface, available as single frames
- **glass** clear glass washed • **easel** up to size 20 x 30 cm / 8" x 11 3/4"
- **suspension rings** for landscape and portrait format
- **B** black | **C** cream | **E** oak | **H** nature | **O** orange | **R** red | **S** silver | **W** white

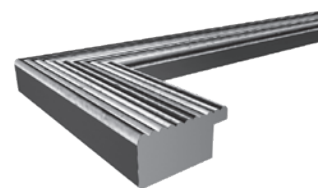
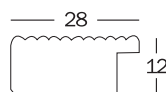

article no.	frame format cm	frame format inch	picture format cm	picture format inch	unit	colours
HI 015 __	10 x 15	3,9 x 5,9	7 x 10	2,8 x 3,9	1	B C E H O R S W
HI 318 __	13 x 18	5,1 x 7,1	9 x 13	3,5 x 5,1	1	B C E H R S W
HI 520 __	15 x 20	5,9 x 7,9	10 x 15	3,9 x 5,9	1	B E H O S W
HI 824 __	18 x 24	7,1 x 9,4	13 x 18	5,1 x 7,1	1	B E H W
HI 030 __	20 x 30	7,9 x 11,8	13 x 18	5,1 x 7,1	1	B E H R S W
HI 430 __	24 x 30	9,4 x 11,8	15 x 20	5,9 x 7,9	1	B E H W
HI 040 __	30 x 40	11,8 x 15,7	20 x 30	7,9 x 11,8	1	B C E H S W
HI 050 __	40 x 50	15,7 x 19,7	30 x 40	11,8 x 15,7	1	B C E H R S W
HI 460 __	40 x 60	15,7 x 23,6	30 x 45	11,8 x 17,7	1	B E H W
HI 070 __	50 x 70	19,7 x 27,6	40 x 60	15,7 x 23,6	1	B E H R S W



NEW! HYGGE profile NC

- **narrow, rectangular MDF profile** with silver inner edge, available as single frames
- **glass** clear glass washed • **easel** up to size 21 x 29,7 cm / 8" x 11 3/4"
- **eyelets** for landscape and portrait format
- **D** grey | **E** oak | **N** walnut | **W** white

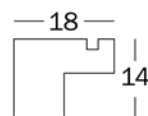

article no.	frame format cm	frame format inch	picture format cm	picture format inch	unit	colours
NC 015 __	10 x 15	3,9 x 5,9	7 x 10	2,8 x 3,9	1	D E N W
NC 318 __	13 x 18	5,1 x 7,1	9 x 13	3,5 x 5,1	1	D E N W
NC 520 __	15 x 20	5,9 x 7,9	10 x 15	3,9 x 5,9	1	D E N W
NC 130 __	21 x 29,7	8,3 x 11,7	13 x 18	5,1 x 7,1	1	D E N W
NC 040 __	30 x 40	11,8 x 15,7	20 x 30	7,9 x 11,8	1	D E N W
NC 050 __	40 x 50	15,7 x 19,7	30 x 40	11,8 x 15,7	1	D E N W

Wooden Frames

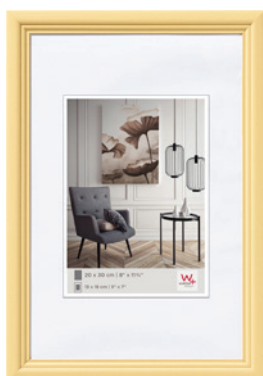

LIVING profile HY

- **fluted wooden profile** available as single frames
- **glass** clear glass washed • **easel** up to size 20 x 30 cm / 8" x 11 ¾"
- **C** cappuccino | **H** nature | **P** hazelnut

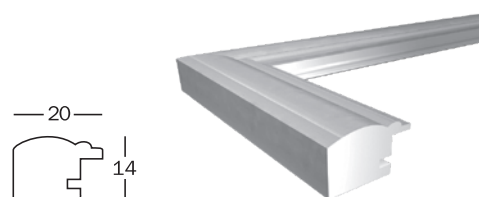

article no.	frame format cm	frame format inch	picture format cm	picture format inch	unit	colours
HY 318 _	13 x 18	5,1 x 7,1	9 x 13	3,5 x 5,1	1	C
HY 824 _	18 x 24	7,1 x 9,4	13 x 18	5,1 x 7,1	1	C H P
HY 030 _	20 x 30	7,9 x 11,8	13 x 18	5,1 x 7,1	1	H
HY 330 _	30 x 30	11,8 x 11,8	18 x 18	7,1 x 7,1	1	C H P
HY 050 _	40 x 50	15,7 x 19,7	30 x 40	11,8 x 15,7	1	C H
HY 460 _	40 x 60	15,7 x 23,6	30 x 45	11,8 x 17,7	1	H



NEW! SILHOUETTE profile NW

- **fluted wooden profile** available as single frames
- **glass** clear glass washed • **easel** up to size 20 x 30 cm / 8" x 11 ¾"
- **B** white/black | **H** white/nature | **P** white/beechnut | **W** white/white

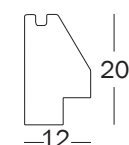

article no.	frame format cm	frame format inch	picture format cm	picture format inch	unit	colours
NW 015 _	10 x 15	3,9 x 5,9	7 x 10	2,8 x 3,9	1	B H P W
NW 318 _	13 x 18	5,1 x 7,1	9 x 13	3,5 x 5,1	1	B H P W
NW 520 _	15 x 20	5,9 x 7,9	10 x 15	3,9 x 5,9	1	B H P W
NW 030 _	20 x 30	7,9 x 11,8	13 x 18	5,1 x 7,1	1	B H P W
NW 040 _	30 x 40	11,8 x 15,7	20 x 30	7,9 x 11,8	1	B H P W

Wooden Frames



BENCH profile ND

- **narrow fluted wooden profile**, available as single frames, whitewash finish
- **glass** clear glass washed • **easel** up to size 20 x 30 cm / 8" x 11 3/4"
- **suspension rings** for landscape and portrait format
- **A** green | **D** grey | **P** brown | **W** white

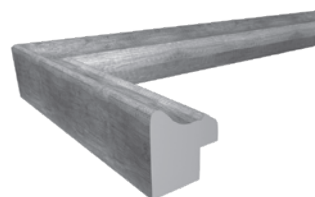
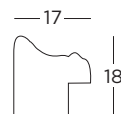

article no.	frame format cm	frame format inch	picture format cm	picture format inch	unit	colours		
ND 015 __	10 x 15	3,9 x 5,9	7 x 10	2,8 x 3,9	1	A	P	W
ND 318 __	13 x 18	5,1 x 7,1	9 x 13	3,5 x 5,1	1		P	
ND 520 __	15 x 20	5,9 x 7,9	10 x 15	3,9 x 5,9	1	D	P	
ND 824 __	18 x 24	7,1 x 9,4	13 x 18	5,1 x 7,1	1	A	D	P W
ND 040 __	30 x 40	11,8 x 15,7	20 x 30	7,9 x 11,8	1	D	P	



METROPOLIS profile IW

- **wooden profile sloping inwards** with foiled surface, available as single frames
- **glass** clear glass washed • **easel** up to size 20 x 30 cm / 8" x 11 3/4"
- **suspension rings** for landscape and portrait format
- **B** black/silver | **W** white/silver

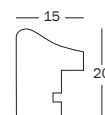

article no.	frame format cm	frame format inch	picture format cm	picture format inch	unit	colours	
IW 015 __	10 x 15	3,9 x 5,9	7 x 10	2,8 x 3,9	1	B	W
IW 318 __	13 x 18	5,1 x 7,1	9 x 13	3,5 x 5,1	1	B	W
IW 520 __	15 x 20	5,9 x 7,9	10 x 15	3,9 x 5,9	1	B	W
IW 030 __	20 x 30	7,9 x 11,8	15 x 20	5,9 x 7,9	1	B	W
IW 040 __	30 x 40	11,8 x 15,7	20 x 30	7,9 x 11,8	1	B	W

Wooden Frames



HOME profile HO

- **rectangular wooden profile** with rough-sawn surface, available as single and gallery frames, special sizes and panoramic frames • **glass** clear glass washed • **easel** up to size 18 x 24 cm / 7" x 9 1/2" • **with bevelled mount**
- **certificate inlay** size 21 x 29,7 cm / DIN A4 / 8 1/4" x 11 3/4" **without mount**
- **B** black | **C** beige brown | **D** grey | **H** nature | **N** walnut
P medium brown | **V** polar white | **W** cream white | **X** light grey

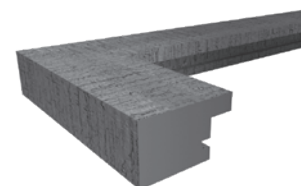
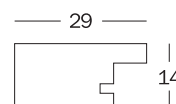

article no.	frame format cm	frame format inch	picture format cm	picture format inch	unit	colours
HO 015 __	10 x 15	3,9 x 5,9	7 x 10	2,8 x 3,9	1	B C D H N P V W X
HO 318 __	13 x 18	5,1 x 7,1	9 x 13	3,5 x 5,1	1	B C D H N V W X
HO 520 __	15 x 20	5,9 x 7,9	10 x 15	3,9 x 5,9	1	B C D H N V W X
HO 824 __	18 x 24	7,1 x 9,4	13 x 18	5,1 x 7,1	1	B C D H V W
HO 030 __	20 x 30	7,9 x 11,8	13 x 18	5,1 x 7,1	1	B C D H N V W X
HO 130 __	21 x 29,7	8,3 x 11,7	13 x 18	5,1 x 7,1	1	B C D V W
HO 430 __	24 x 30	9,4 x 11,8	15 x 20	5,9 x 7,9	1	B C D H V W
HO 040 __	30 x 40	11,8 x 15,7	20 x 30	7,9 x 11,8	1	B C D H N V W
HO 045 __	30 x 45	11,8 x 17,7	20 x 30	7,9 x 11,8	1	B C D H V W
HO 050 __	40 x 50	15,7 x 19,7	30 x 40	11,8 x 15,7	1	B C D H N V W X
HO 460 __	40 x 60	15,7 x 23,6	30 x 45	11,8 x 17,7	1	B C D V W X
HO 060 __	50 x 60	19,7 x 23,6	40 x 50	15,7 x 19,7	1	B V W
HO 070 __	50 x 70	19,7 x 27,6	40 x 60	15,7 x 23,6	1	B C D H N V W
HO 080 __	60 x 80	23,6 x 31,5	50 x 70	19,7 x 27,6	1	B C D N V W X
HO 090 __	60 x 90	23,6 x 35,4	42 x 59,4	16,5 x 23,4	1	B C D N V W
HO 100 __	70 x 100	27,6 x 39,4	50 x 70	19,7 x 27,6	1	B C D N V W
HO 220 __	20 x 20	7,9 x 7,9	15 x 15	5,9 x 5,9	1	B C D N V W X
HO 330 __	30 x 30	11,8 x 11,8	18 x 18	7,1 x 7,1	1	B C D N V W X
HO 440 __	40 x 40	15,7 x 15,7	28 x 28	11 x 11	1	B C D N V W X
HO 550 __	50 x 50	19,7 x 19,7	35 x 35	13,8 x 13,8	1	B C D V W

Wooden Frames

HOME profile HO



- **rectangular wooden profile** with rough-sawn surface, available as single and gallery frames, special sizes and panoramic frames • **glass** clear glass washed
- **C** beige brown | **D** grey | **N** walnut | **X** light grey



article no.	frame format cm	frame format inch	picture format cm	picture format inch	unit	colours			
HO 120	10 x 20	3,9 x 7,9			1	D	N	X	
HO 153	15 x 30	5,9 x 11,8			1	C			
HO 500 _	50 x 100	19,7 x 39,4			1			X	

HOME profile HO



- **rectangular wooden profile** with rough-sawn surface, available as single and gallery frames, special sizes and panoramic frames • **glass** clear glass washed
- **with bevelled mount**
- **B** black | **C** beige brown | **D** grey | **H** nature | **N** walnut | **V** polar white | **W** cream white



article no.	frame format cm	frame format inch	picture format cm	picture format inch	unit	colours			
HO 215 _	23 x 31,5	9,1 x 12,4	2 x 10x15	2x 3,9 x 5,9	1	B C D		V	W
HO 218 _	25,4 x 35,5	10 x 14	2 x 13x18	2x 5,1 x 7,1	1	B D			W
HO 252 _	27,8 x 40,5	10,9 x 15,9	2 x 15x20	2x 5,9 x 7,9	1			N	
HO 315 _	23 x 46	9,1 x 18,1	3 x 10x15	3x 3,9 x 5,9	1	B C D H		V	W
HO 338 _	25,4 x 50,7	10 x 20	3 x 13x18	3x 5,1 x 7,1	1	B C D H		V	W
HO 352 _	27,8 x 58,2	10,9 x 22,9	3 x 15x20	3x 5,9 x 7,9	1	B C D		V	W
HO 515 _	23, x 72	9,1 x 28,3	5 x 10x15	5x 3,9 x 5,9	1	B C D	N	V	W
HO 555 M	53 x 53	20,9 x 20,9	5 x 13x18 1 x 10x10	5x 5,1 x 7,1 1x 3,9 x 3,9	1	1 x black, 2 x light grey, 2 x grey, 1 x white			
HO 666 M	43 x 43	16,9 x 16,9	5 x 10x15 1 x 10x10	5x 3,9 x 5,9 1x 3,9 x 3,9	1	1 x black, 2 x light grey, 2 x grey, 1 x white			

Wooden Frames



PEPPERS profile BP

- **rectangular wooden profile** matt surface, available as single frames • **glass** clear glass washed
- **easel** up to size 21 x 30 cm / 8 ¼" x 11 ¾"
- **gallery hanging system** from size 40 x 50 cm / 15 ¾" x 19 ¾"
- **certificate inlay** size 21 x 29,7 cm / DIN A4 / 8 ¼" x 11 ¾"
- **B** black | **D** grey | **E** oak | **G*** gold | **H** nature | **K** pine | **L** dark blue | **N** walnut | **P** beech-tree
Q brilliant red | **R** mahogany | **S*** silver | **V** polar white • ***** foiled surface

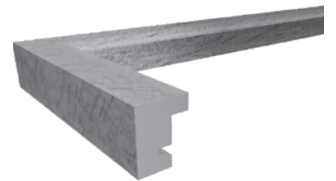
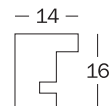

article no.	frame format cm	frame format inch	picture format cm	picture format inch	unit	colours
BP 710 __	7 x 10	2,8 x 3,9	3,5 x 4,5	1,4 x 1,8	1	B E G K N P S V
BP 913 __	9 x 13	3,5 x 5,1	5 x 7	2 x 2,8	1	B D E G K N P S V
BP 015 __	10 x 15	3,9 x 5,9	7 x 10	2,8 x 3,9	1	B E G K N P Q S V
BP 318 __	13 x 18	5,1 x 7,1	9 x 13	3,5 x 5,1	1	B D E G H K N P Q R S V
BP 520 __	15 x 20	5,9 x 7,9	10 x 15	3,9 x 5,9	1	B D E K L N P R S V
BP 824 __	18 x 24	7,1 x 9,4	13 x 18	5,1 x 7,1	1	B E G K N P S V
BP 028 __	20 x 28	7,9 x 11	13 x 18	5,1 x 7,1	1	G H R S
BP 030 __	20 x 30	7,9 x 11,8	13 x 18	5,1 x 7,1	1	B E G K N P S V
BP 130 __	21 x 29,7	8,3 x 11,7	13 x 18	5,1 x 7,1	1	B D E G K N P S V
BP 430 __	24 x 30	9,4 x 11,8	15 x 20	5,9 x 7,9	1	B N V
BP 040 __	30 x 40	11,8 x 15,7	20 x 30	7,9 x 11,8	1	B D E G K N P S V
BP 342 __	29,7 x 42	11,7 x 16,5	18 x 24	7,1 x 9,4	1	B N V
BP 045 __	30 x 45	11,8 x 17,7	20 x 30	7,9 x 11,8	1	B N V
BP 050 __	40 x 50	15,7 x 19,7	30 x 40	11,8 x 15,7	1	B E G K L N P S V
BP 460 __	40 x 60	15,7 x 23,6	30 x 45	11,8 x 17,7	1	B N V
BP 070 __	50 x 70	19,7 x 27,6	40 x 60	15,7 x 23,6	1	B H N V
BP 010 __	10 x 10	3,9 x 3,9	7 x 7	2,8 x 2,8	1	B G N S V
BP 313 __	13 x 13	5,1 x 5,1	9 x 9	3,5 x 3,5	1	B D G N S V
BP 150 __	15 x 15	5,9 x 5,9	10 x 10	3,9 x 3,9	1	B D E G N S V
BP 020 __	20 x 20	7,9 x 7,9	13 x 13	5,1 x 5,1	1	B G N P V
BP 330 __	30 x 30	11,8 x 11,8	18 x 18	7,1 x 7,1	1	B E N V



PEPPERS profile BP

- **rectangular wooden profile** matt surface, available as single frames
- **glass** clear glass washed
- **gallery hanging system** from size 40 x 50 cm / 15 ¾" x 19 ¾"
- **with bevelled mount**
- **B** black | **D** grey | **H** nature | **N** walnut | **V** polar white



article no.	frame format cm	frame format inch	picture format cm	picture format inch	unit	colours
BP 315 __	23 x 46	9,1 x 18,1	3x 10X15	3x 3,9 x 5,9	1	B D H N V
BP 338 __	25,4 x 50,7	10 x 20	3x 13X18	3x 5,1 x 7,1	1	B D V

Wooden Frames



NEW! SELECT profile HSX with artificial glass

- **narrow, fluted profile**, available as single frames
- **glass** artificial glass • **foiled surface**
- **suspension rings** for landscape and portrait format
- **B** black | **H** nature | **P** brown | **W** white

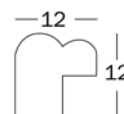

article no.	frame format cm	frame format inch	picture format cm	picture format inch	unit	colours
HSX 015 __	10 x 15	3,9 x 5,9	7 x 10	2,8 x 3,9	1	B H P W
HSX 318 __	13 x 18	5,1 x 7,1	9 x 13	3,5 x 5,1	1	B H P W
HSX 520 __	15 x 20	5,9 x 7,9	10 x 15	3,9 x 5,9	1	B H P W
HSX 030 __	20 x 30	7,9 x 11,8	13 x 18	5,1 x 7,1	1	B H P W
HSX 040 __	24 x 30	9,4 x 11,8	15 x 20	5,9 x 7,9	1	B H P W



FIORITO profile EFX with artificial glass

- **MDF profile sloping inwards** textured, available as single frames
- **glass** artificial glass • **foiled surface** • **with bevelled mount**
- **suspension rings** for landscape and portrait format • **gallery hanging system** from size 40 x 50 cm / 15 ¾" x 19 ¾"
- **D** dark grey | **E** light oak | **N** walnut | **P** dark oak | **W** white

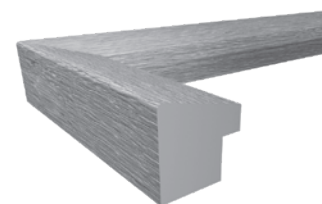
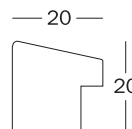

article no.	frame format cm	frame format inch	picture format cm	picture format inch	unit	colours
EFX 130 __	21 x 29,7	8,3 x 11,7	DIN A4		1	D E N P W
EFX 040 __	30 x 40	11,8 x 15,7	20 x 30	7,9 x 11,8	1	D E N P W
EFX 050 __	40 x 50	15,7 x 19,7	30 x 40	11,8 x 15,7	1	D E N P W
EFX 460 __	40 x 60	15,7 x 23,6	30 x 45	11,8 x 17,7	1	D E N P W
EFX 060 __	50 x 60	19,7 x 23,6	40 x 50	15,7 x 19,7	1	D E N P W
EFX 070 __	50 x 70	19,7 x 27,6	40 x 60	15,7 x 23,6	1	D E N P W
EFX 080 __	60 x 80	23,6 x 31,5	50 x 70	19,7 x 27,6	1	D E N P W

Wooden Frames



FIORITO profile EF

- **MDF profile sloping inwards** textured, available as single frames
- **glass** clear glass washed • **easel** up to size 20 x 30 cm / 8" x 11 3/4" • **foiled surface** • **with bevelled mount**
- **suspension rings** for landscape and portrait format • **gallery hanging system** from size 40 x 50 cm / 15 3/4" x 19 3/4"
- **D** dark grey | **E** light oak | **N** walnut | **P** dark oak | **W** white

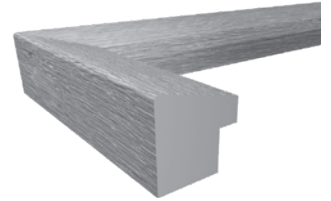
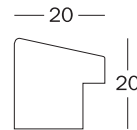

article no.	frame format cm	frame format inch	picture format cm	picture format inch	unit	colours
EF 015	10 x 15	3,9 x 5,9	7 x 10	2,8 x 3,9	1	D E N P W
EF 318	13 x 18	5,1 x 7,1	9 x 13	3,5 x 5,1	1	D E N P W
EF 520	15 x 20	5,9 x 7,9	10 x 15	3,9 x 5,9	1	D E N P W
EF 824	18 x 24	7,1 x 9,4	13 x 18	5,1 x 7,1	1	D E N P W
EF 030	20 x 30	7,9 x 11,8	13 x 18	5,1 x 7,1	1	D E N P W
EF 430	24 x 30	9,4 x 11,8	15 x 20	5,9 x 7,9	1	D E N P W
EF 040	30 x 40	11,8 x 15,7	20 x 30	7,9 x 11,8	1	D E N P W
EF 045	30 x 45	11,8 x 17,7	20 x 30	7,9 x 11,8	1	D E N P W
EF 050	40 x 50	15,7 x 19,7	28 x 35	11 x 13,7	1	D E N P W
EF 460	40 x 60	15,7 x 23,6	30 x 45	11,8 x 17,7	1	D E N P W
EF 060	50 x 60	19,7 x 23,6	30 x 40	11,7 x 15,7	1	D E N P W
EF 070	50 x 70	19,7 x 27,6	40 x 50	15,7 x 19,7	1	D E N P W
EF 080	60 x 80	23,6 x 31,5	40 x 60	15,7 x 23,6	1	D E N P W
EF 220	20 x 20	7,9 x 7,9	13 x 13	5,1 x 5,1	1	D E N P W
EF 330	30 x 30	11,8 x 11,8	18 x 18	7,1 x 7,1	1	D E N P W
EF 440	40 x 40	15,7 x 15,7	28 x 28	11 x 11	1	E N W
EF 440	40 x 40	15,7 x 15,7	30 x 30	11,8 x 11,8	1	D P
EF 315V	18 X 61	7,1 x 24	3x 10x15	3x 3,9 x 5,9	1	D E N P W
EF 338V	20 x 66	7,9 x 26	3x 13x18	3x 5,1 x 7,1	1	D E N P W
EF 515	51 x 17	20,1 x 6,7	5x 10x15	5x 3,9 x 5,9	1	M colour mix



NEW! STOCKHOLM profile EA 3D Jersey Frame with artificial glass

- **deep MDF block profile**
- **with hanger for hanging up the garment**
- **glass** artificial glass • **suspension rings** for landscape format • **foiled surface**
- **B** black | **D** grey | **W** white

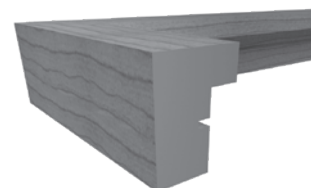
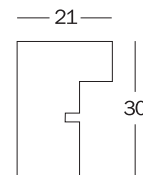

article no.	frame format cm	frame format inch	picture format	unit	colours
EA 690	60 x 90	23,6 x 35,4	Jersey	1	B D W

Wooden Frames



STOCKHOLM profile EA **NEW FORMAT!**

- **MDF block profile** textured, available as single frames
- **with bevelled mount**
- **glass** clear glass washed • **easel** up to size 20 x 30 cm / 8" x 11 3/4" • **foiled surface**
- **B** black | **D** grey | **H** nature | **N** walnut | **P** beech-tree | **W** white

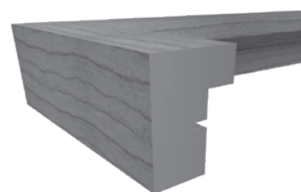
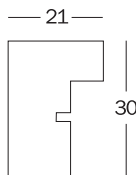

EA315B



article no.	frame format cm	frame format inch	picture format cm	picture format inch	unit	colours
EA 015	10 x 15	3,9 x 5,9	7 x 10	2,8 x 3,9	1	B D H N P W
EA 318	13 x 18	5,1 x 7,1	9 x 13	3,5 x 5,1	1	B D H N P W
EA 520	15 x 20	5,9 x 7,9	10 x 15	3,9 x 5,9	1	B D H N P W
EA 030	20 x 30	7,9 x 11,8	13 x 18	5,1 x 7,1	1	B D H N P W
EA 040	30 x 40	11,8 x 15,7	20 x 30	7,9 x 11,8	1	B D H N P W
EA 045	30 x 45	11,8 x 17,7	20 x 30	7,9 x 11,8	1	B D H N P W
EA 050	40 x 50	15,7 x 19,7	30 x 40	11,8 x 15,7	1	B D H N P W
EA 460	40 x 60	15,7 x 23,6	30 x 45	11,8 x 17,7	1	B D H N P W
EA 070	50 x 70	19,7 x 27,6	40 x 60	15,7 x 23,6	1	B D N W
EA 080	60 x 80	23,6 x 31,5	50 x 70	19,7 x 27,6	1	B D W
EA 100	70 x 100	27,6 x 39,4	50 x 70	19,7 x 27,6	1	B D W
EA 330	30 x 30	11,8 x 11,8	18 x 18	7,1 x 7,1	1	B D W
EA 315	64 x 20	25,2 x 7,9	3x10 x 15	3x3,9 x 5,9	1	B W



EA222B

STOCKHOLM profile EA 3D **NEW FORMAT!**

- **deep MDF block profile** textured, available as single frames
- **EA222, EA339 and EA444** with an extra inner frame for a variable positioning of the picture
- **with bevelled mount**
- **glass** clear glass washed, **EA450 with artificial glass** • **easel** up to size 20 x 30 cm / 8" x 11 3/4" • **foiled surface**
- **B** black | **D** grey | **W** white



EA333B



article no.	frame format cm	frame format inch	picture format cm	picture format inch	unit	colours
EA 222	20 x 20	7,9 x 7,9	10 x 10	3,9 x 3,9	1	B D W
EA 339	30 x 30	11,8 x 11,8	18 x 18	7,1 x 7,1	1	B D W
EA 444	40 x 40	15,7 x 15,7	30 x 30	11,8 x 11,8	1	B D W
EA 450	40 x 50	15,7 x 19,7	30 x 40	11,8 x 15,7	1	B D W artificial glass
EA 333 *	30 x 30	11,8 x 11,8	10 x 15	3,9 x 5,9	1	B
EA 411 *	40 x 40	15,7 x 15,7	4x10 x 10	4x 3,9 x 3,9	1	B

* double mount

Wooden Frames



BAROCK profile CR **NEW COLOUR!**

- **ornament, fluted wooden profile** with relief surface, available as single frames
- **glass** clear glass washed • **easel** up to size 20 x 30 cm / 8" x 11 3/4" • **with double mount**
- **gallery hanging system** from size 40 x 50 cm / 15 3/4" x 19 3/4"
- **B** black/silver | **D** anthracite | **G** gold | **W** white

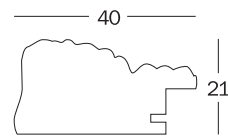

article no.	frame format cm	frame format inch	picture format cm	picture format inch	unit	colours
CR 318 __	13 x 18	5,1 x 7,1	9 x 13	3,5 x 5,1	1	D W
CR 030 __	20 x 30	7,9 x 11,8	15 x 20	5,9 x 7,9	1	B D G W
CR 040 __	30 x 40	11,8 x 15,7	20 x 30	7,9 x 11,8	1	B D G W
CR 050 __	40 x 50	15,7 x 19,7	30 x 40	11,8 x 15,7	1	B D G W
CR 070 __	50 x 70	19,7 x 27,6	40 x 60	15,7 x 23,6	1	W



NIZZA profile HQ

- **wide wooden profile**, available as single frames
- **glass** clear glass washed • **easel** up to size 20 x 30 cm / 8" x 11 3/4"
- **suspension rings** for landscape and portrait format
- **H** nature | **M** meranti | **N** walnut | **S** silver | **W** white

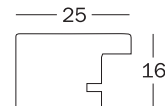

article no.	frame format cm	frame format inch	picture format cm	picture format inch	unit	colours
HQ 015 __	10 x 15	3,9 x 5,9	7 x 10	2,8 x 3,9	1	H M N S W
HQ 318 __	13 x 18	5,1 x 7,1	9 x 13	3,5 x 5,1	1	H M N S W
HQ 520 __	15 x 20	5,9 x 7,9	10 x 15	3,9 x 5,9	1	N
HQ 030 __	20 x 30	7,9 x 11,8	13 x 18	5,1 x 7,1	1	S W
HQ 050 __	40 x 50	15,7 x 19,7	30 x 40	11,8 x 15,7	1	H
HQ 070 __	50 x 70	19,7 x 27,6	40 x 60	15,7 x 23,6	1	M N

Permanent Promotion



MEMORY profile EM 4 profiles

- **profile 1 = wide, sloping inwards polystyrene profile** available as single frames in 3 colours
- **profile 2 = wide fluted polystyrene profile** with decorative groove inside, available as single frame in 3 colours
- **profile 3 = wide fluted polystyrene profile** available as single frame in 3 colours
- **profile 4 = fluted polystyrene profile** with decorative groove inside and outside, available as single frame in 3 colours
- **foiled surface · glass** clear glass washed · **easel** up to size 20 x 30 cm / 8" x 11 3/4"
- **suspension** suspension rings for landscape and portrait format
- silver | gold | antracite

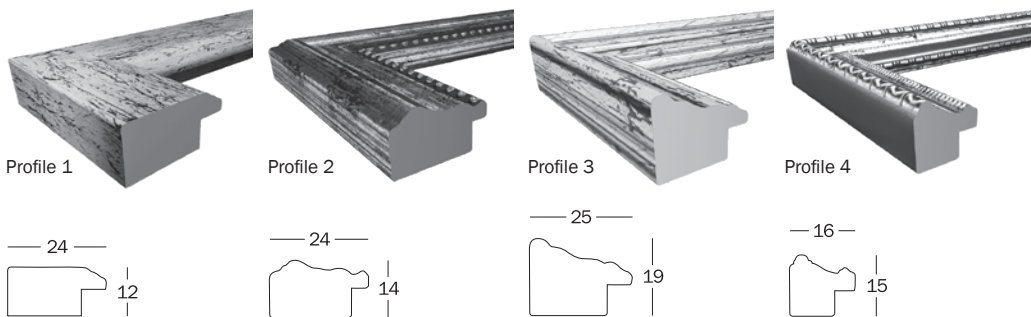

article no.	frame format cm	frame format inch	picture format cm	picture format inch	unit
EM 015 M	10 x 15	3,9 x 5,9	7 x 10	2,8 x 3,9	25
EM 318 M	13 x 18	5,1 x 7,1	9 x 13	3,5 x 5,1	30
EM 520 M	15 x 20	5,9 x 7,9	10 x 15	3,9 x 5,9	25
EM 030 M	20 x 30	7,9 x 11,8	15 x 20	5,9 x 7,9	20
EM 040 M	30 x 40	11,8 x 15,7	20 x 30	7,9 x 11,8	15
EM 050 M	40 x 50	15,7 x 19,7	30 x 40	11,8 x 15,7	10

Aluminium Frames



CHAIR profile AJ

- **aluminium block profile** with matt brushed surface, available as single frames
- **glass** clear glass washed • **easel** up to size 21 x 29,7 cm / 8,3" x 11 3/4" • **with bevelled mount** only for square sizes
- **gallery hanging system** from size 40 x 50 cm / 15 3/4" x 19 3/4"
- **certificate inlay** size 21 x 29,7 cm / DIN A4 / 8 1/4" x 11 3/4" (illustration see below)
- **B** black | **D** steel | **G** gold | **S** silver | **W** white

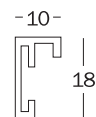

article no.	frame format cm	frame format inch	picture format cm	picture format inch	unit	colours			
AJ 015 __	10 x 15	3,9 x 5,9	7 x 10	2,8 x 3,9	1	B	D	G	S
AJ 318 __	13 x 18	5,1 x 7,1	9 x 13	3,5 x 5,1	1	B	D	G	S
AJ 520 __	15 x 20	5,9 x 7,9	10 x 15	3,9 x 5,9	1	B	D	G	S
AJ 824 __	18 x 24	7,1 x 9,4	13 x 18	5,1 x 7,1	1				S
AJ 030 __	20 x 30	7,9 x 11,8	13 x 18	5,1 x 7,1	1	B	D	G	S
AJ 130 __	21 x 29,7	8,3 x 11,7	DIN A4		1	B	D	G	S
AJ 342 __	29,7 x 42	11,7 x 16,5	DIN A3		1	B	D	G	S
AJ 040 __	30 x 40	11,8 x 15,7	20 x 30	7,9 x 11,8	1	B	D	G	S
AJ 045 __	30 x 45	11,8 x 17,7	20 x 30	7,9 x 11,8	1	B	D	G	S
AJ 050 __	40 x 50	15,7 x 19,7	30 x 40	11,8 x 15,7	1	B	D	G	S
AJ 460 __	40 x 60	15,7 x 23,6	30 x 45	11,8 x 17,7	1	B	D	G	S
AJ 426 __	42 x 59,4	16,5 x 23,4	DIN A2		1	B	D	G	S
AJ 060 __	50 x 60	19,7 x 23,6	40 x 50	15,7 x 19,7	1				S
AJ 070 __	50 x 70	19,7 x 27,6	40 x 60	15,7 x 23,6	1	B	D	G	S
AJ 684 __	59,4 x 84	23,4 x 33,1	DIN A1		1	B	D	G	S W
AJ 080 __	60 x 80	23,6 x 31,5	50 x 70	19,7 x 27,6	1	B	D	G	S
AJ 100 __	70 x 100	27,6 x 39,4	50 x 70	19,7 x 27,6	1	B	D	G	S
AJ 220 __	20 x 20	7,9 x 7,9	13 x 13	5,1 x 5,1	1		D	G	
AJ 220 __	20 x 20	7,9 x 7,9	15 x 15	5,9 x 5,9	1	B			S
AJ 330 __	30 x 30	11,8 x 11,8	18 x 18	7,1 x 7,1	1	B	D	G	S
AJ 440 __	40 x 40	15,7 x 15,7	28 x 28	11 x 11	1		D	G	S

Aluminium Frames



ALULINE profile AL

- **rectangular aluminium profile** with matt brushed surface, available as single frames
- **glass** clear glass washed • **easel** up to size 20 x 30 cm / 8" x 11 3/4" • **with bevelled mount**
- **suspension rings** for landscape and portrait format • **gallery hanging system** from size 40 x 50 cm / 15 3/4" x 19 3/4"
- **D** steel | **S** silver

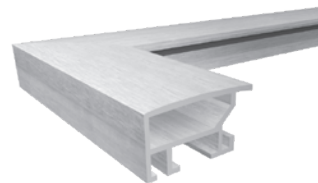
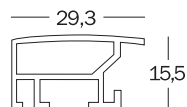

article no.	frame format cm	frame format inch	picture format cm	picture format inch	unit	colours
AL 318 __	13 x 18	5,1 x 7,1	9 x 13	3,5 x 5,1	1	D
AL 520 __	15 x 20	5,9 x 7,9	10 x 15	3,9 x 5,9	1	D S
AL 030 __	20 x 30	7,9 x 11,8	13 x 18	5,1 x 7,1	1	D S
AL 130 __	21 x 29,7	8,3 x 11,7	13 x 18	5,1 x 7,1	1	D S
AL 040 __	30 x 40	11,8 x 15,7	20 x 30	7,9 x 11,8	1	D S
AL 045 __	30 x 45	11,8 x 17,7	20 x 30	7,9 x 11,8	1	D S
AL 050 __	40 x 50	15,7 x 19,7	30 x 40	11,8 x 15,7	1	D S
AL 460 __	40 x 60	15,7 x 23,6	30 x 45	11,8 x 17,7	1	S
AL 070 __	50 x 70	19,7 x 27,6	40 x 60	15,7 x 23,6	1	D S

Clip Frames



CLIP FRAMES RB

- **clip frames**
- **glass** clear glass polished and washed
- **certificate inlay** size 21 x 29,7 cm / DIN A4 / 8 ¼" x 11 ¾"

article no.	frame format cm	frame format inch	picture format cm	picture format inch	unit
RB 015 K	10 x 15	3,9 x 5,9	7 x 10	2,8 x 3,9	1
RB 318 K	13 x 18	5,1 x 7,1	9 x 13	3,5 x 5,1	1
RB 520 K	15 x 20	5,9 x 7,9	10 x 15	3,9 x 5,9	1
RB 521 K	15 x 21	5,9 x 8,3	10 x 15	3,9 x 5,9	1
RB 824 K	18 x 24	7,1 x 9,4	13 x 18	5,1 x 7,1	1
RB 025 K	20 x 25	7,9 x 9,8	13 x 18	5,1 x 7,1	1
RB 030 K	20 x 30	7,9 x 11,8	13 x 18	5,1 x 7,1	1
RB 130 K	21 x 29,7	8,3 x 11,7	13 x 18	5,1 x 7,1	1
RB 430 K	24 x 30	9,4 x 11,8	15 x 20	5,9 x 7,9	1
RB 835 K	28 x 35	11 x 13,8	18 x 24	7,1 x 9,4	1
RB 330 K	30 x 30	11,8 x 11,8	18 x 18	7,1 x 7,1	1
RB 040 K	30 x 40	11,8 x 15,7	20 x 30	7,9 x 11,8	1
RB 342 K	29,7 x 42	11,7 x 16,5	18 x 24	7,1 x 9,4	1
RB 045 K	30 x 45	11,8 x 17,7	20 x 30	7,9 x 11,8	1
RB 050 K	40 x 50	15,7 x 19,7	30 x 40	11,8 x 15,7	1
RB 460 K	40 x 60	15,7 x 23,6	30 x 45	11,8 x 17,7	1
RB 426 K	42 x 59,4	16,5 x 23,4	30 x 45	11,8 x 17,7	1
RB 060 K	50 x 60	19,7 x 23,6	40 x 50	15,7 x 19,7	1
RB 070 K	50 x 70	19,7 x 27,6	40 x 60	15,7 x 23,6	1
RB 080 K	60 x 80	23,6 x 31,5	50 x 70	19,7 x 27,6	1
RB 684 K	59,4 x 84	23,4 x 33,1	40 x 60	15,7 x 23,6	1
RB 090 K	60 x 90	23,6 x 35,4	42 x 59,4	16,5 x 23,4	1
RB 100 K	70 x 100	27,6 x 39,4	50 x 70	19,7 x 27,6	1

Clip Frames

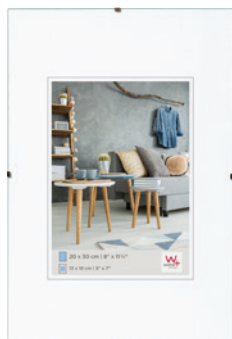

CLIP FRAMES RB

- **clip frames**
- **glass** anti-reflective glass polished and washed
- **certificate inlay** size 21 x 29,7 cm / DIN A4 / 8 1/4" x 11 3/4"

article no.	frame format cm	frame format inch	picture format cm	picture format inch	unit
RB 015 A	10 x 15	3,9 x 5,9	7 x 10	2,8 x 3,9	1
RB 318 A	13 x 18	5,1 x 7,1	9 x 13	3,5 x 5,1	1
RB 520 A	15 x 20	5,9 x 7,9	10 x 15	3,9 x 5,9	1
RB 521 A	15 x 21	5,9 x 8,3	10 x 15	3,9 x 5,9	1
RB 824 A	18 x 24	7,1 x 9,4	13 x 18	5,1 x 7,1	1
RB 030 A	20 x 30	7,9 x 11,8	13 x 18	5,1 x 7,1	1
RB 130 A	21 x 29,7	8,3 x 11,7	13 x 18	5,1 x 7,1	1
RB 430 A	24 x 30	9,4 x 11,8	15 x 20	5,9 x 7,9	1
RB 835 A	28 x 35	11 x 13,8	18 x 24	7,1 x 9,4	1
RB 040 A	30 x 40	11,8 x 15,7	20 x 30	7,9 x 11,8	1
RB 342 A	29,7 x 42	11,7 x 16,5	18 x 24	7,1 x 9,4	1
RB 045 A	30 x 45	11,8 x 17,7	20 x 30	7,9 x 11,8	1
RB 050 A	40 x 50	15,7 x 19,7	30 x 40	11,8 x 15,7	1
RB 460 A	40 x 60	15,7 x 23,6	30 x 45	11,8 x 17,7	1
RB 426 A	42 x 60	16,5 x 23,6	30 x 45	11,8 x 17,7	1
RB 060 A	50 x 60	19,7 x 23,6	40 x 50	15,7 x 19,7	1
RB 070 A	50 x 70	19,7 x 27,6	40 x 60	15,7 x 23,6	1
RB 080 A	60 x 80	23,6 x 31,5	50 x 70	19,7 x 27,6	1
RB 090 A	60 x 90	23,6 x 35,4	42 x 59,4	16,5 x 23,4	1
RB 100 A	70 x 100	27,6 x 39,4	50 x 70	19,7 x 27,6	1

Mounts



PASSEPARTOUT PA

- **mount thickness** 1,4 mm / 0,05"
- **white inner cut** • **acid-free cardboard** • **exact die-cut**
- available in 10 colours
- **B** black | **C** cream | **D** grey | **H** chamois | **L** dark blue | **R** red | **S** polar white | **W** snow white



article no.	frame format cm	frame format inch	picture format cm	picture format inch	unit	colours
PA 318 __	13 x 18	5,1 x 7,1	9 x 13	3,5 x 5,1	1	B C D H S W
PA 520 __	15 x 20	5,9 x 7,9	10 x 15	3,9 x 5,9	1	B C D H S W
PA 825 __	18 x 24	7,1 x 9,4	13 x 18	5,1 x 7,1	1	B H S
PA 030 __	20 x 30	7,9 x 11,8	13 x 18	5,1 x 7,1	1	B C D H S W
PA 430 __	24 x 30	9,4 x 11,8	15 x 20	5,9 x 7,9	1	C H S W
PA 431 __	24 x 30	9,4 x 11,8	18 x 24	7,1 x 9,4	1	H S
PA 040 __	30 x 40	11,8 x 15,7	20 x 28	7,9 x 11,8	1	B C D H L R S W
PA 041 __	30 x 40	11,8 x 15,7	20 x 30	7,9 x 11,8	1	B C D H S W
PA 042 __	30 x 40	11,8 x 15,7	21 x 29,7	8,3 x 11,7	1	H S
PA 045 __	30 x 45	11,8 x 17,7	20 x 30	7,9 x 11,8	1	B H S
PA 051 __	40 x 50	15,7 x 19,7	30 x 40	11,8 x 15,7	1	B C D H S W
PA 460 __	40 x 60	15,7 x 23,6	30 x 45	11,8 x 17,7	1	B C H S W
PA 070 __	50 x 70	19,7 x 27,6	40 x 60	15,7 x 23,6	1	B C H S W
PA 071 __	50 x 70	19,7 x 27,6	40 x 60	15,7 x 23,6	1	B C H S W
PZ 180 __ *	100 x 80	39,4 x 31,5	divers		1	B C H S W

* Large sheet, uncut, 12 pieces

Art Supplies



CANVAS HDCVS / HDCVD

- 18 sizes with 3 different frame thicknesses
- triple primed, for oil & acrylic paints and water colours
- large sizes with braces (see chart)
- sorted by sizes

article no.	frame format cm	frame format inch	unit	strength
HDCVS001	10 X 10	3,9 x 3,9	20	1,5x2 cm
HDCVS002	13 X 18	5,1 x 7,1	20	1,5x2 cm
HDCVS004	18 X 24	7,1 x 9,4	20	1,5x2 cm
HDCVS003	20 X 20	7,9 x 7,9	20	1,5x2 cm
HDCVS005	24 X 30	9,4 x 11,8	10	1,5x2 cm
HDCVS006	30 X 30	11,8 x 11,8	10	1,5x2 cm
HDCVS007	30 X 40	11,8 x 15,7	10	1,5x2 cm
HDCVS023	20 x 50	7,9 x 19,7	10	1,5x2 cm
HDCVS013	30 x 100	11,8 x 39,4	5	1,5x3,5 cm
HDCVS008	40 X 40	15,7 x 15,7	10	1,5x3,5 cm
HDCVS009	40 X 50	15,7 x 19,7	10	1,5x3,5 cm
HDCVS010	50 X 50	19,7 x 19,7	10	1,5x3,5 cm
HDCVS011	50 X 70	19,7 x 27,6	5	1,5x3,5 cm
HDCVS015	50 X 100	19,7 x 39,4	5	1,5x3,5 cm
HDCVS012	60 X 80	23,6 x 31,5	5	1,5x3,5 cm
HDCVS014	70 X 100	27,6 x 39,4	5	1,5x3,5 cm
HDCVS016	90 x 120	35,4 x 47,2	5	1,5x3,5 cm
HDCVD006	100 x 120	39,4 x 47,2	5	3x3,5 cm



PAINTING CARDBOARD HDZAK

- 4 sizes
- triple primed, for oil & acrylic paints and water colours

article no.	frame format cm	frame format inch	unit
HDZAK001	13 X 18	5,1 x 7,1	25
HDZAK002	18 X 24	7,1 x 9,4	25
HDZAK003	24 X 30	9,4 x 11,8	15
HDZAK004	30 X 40	11,8 x 15,7	15

Art Supplies



EASEL HDZAS

- lightweight easel, made of pine wood
- height adjustment with screw fixation



article no.	format cm	format inch	unit
HDZAS005	84 x 8 x 10,5	33 x 3,1 x 4,1	4



PAINTS HDZAF

- a set of acrylic paints
- different acrylic paints in single tubes



article no.	content	unit	colours
HDZAF007	12 x 12 ml	12	12 colors assorted
HDZAF009	75 ml	12	white
HDZAF010	75 ml	12	black
HDZAF011	75 ml	12	red
HDZAF012	75 ml	12	dark blue
HDZAF013	75 ml	12	gold
HDZAF014	75 ml	12	yellow
HDZAF015	75 ml	12	green
HDZAF016	75 ml	12	silver
HDZAF017	75 ml	12	bronze
HDZAF018	75 ml	12	turquoise
HDZAF019	75 ml	12	violet

Art Supplies



BRUSH SET HDZAF

- brush set with 5 round and 5 flat brushes each

article no.	unit
HDZAF023	10



PIN BOARDS HDZAW

- pin boards in 2 sizes
- cork in a rectangular wooden frame, nature
- including fastening material and 6 pin board needles



article no.	format cm	format inch	unit
HDZAW025	40 X 60	15,7 x 23,6	8
HDZAW026	60 X 80	23,6 x 31,5	6



MAGNETIC BOARDS HDZAM

- magnetic board and magnetic weekly planner (with German Text)
- in a rectangular wooden frame, white/nature, writable
- including fastening material and 3 magnets and a pen

article no.	format cm	format inch	unit
HDZAM027	40 X 60	15,7 x 23,6	8
HDZAM028	40 X 60	15,7 x 23,6	8

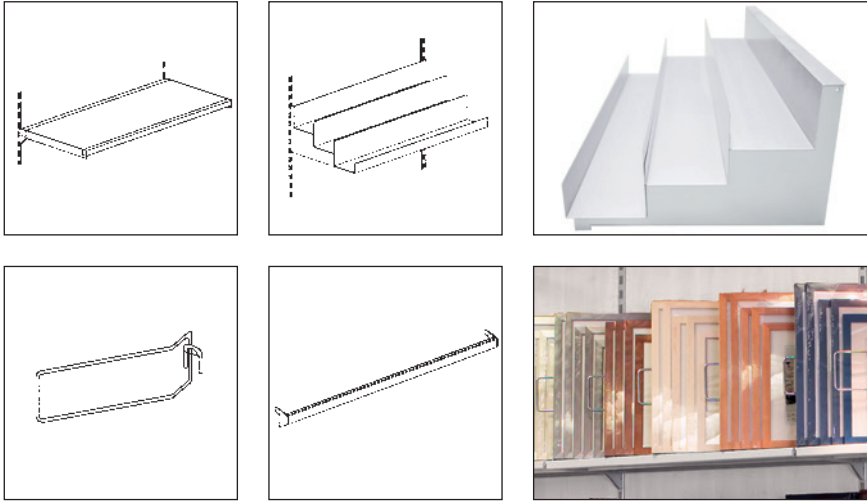

• Stage Employments

All frame sizes up to 24 x 30 cm / 9 1/2" x 11 3/4" can be presented frontally in three-stage hanging modules, they can be presented frontally.

• Separation Handles

Special separation handles make it possible to slope larger frame sizes.

The Professional Presentation Solution for Picture Frames

Modular and flexible design.

The elements can be combined with all shop systems with 1,00 m / 39 1/3" and 1,25 m / 49 1/4" axis.

Effective in your sales space, for increasing sales and profit. Functional and visually appealing design.

Description
shelf, depth 36 cm / 14"
grooved rubber, 100 x 36 cm / 39 1/3" x 14"
tri-leveld stage employment, length 100 cm / 39 1/3"
carrier rail, length 100 cm / 39 1/3"
separation handles
L profile, length 63 cm / 24 3/4", height 232 cm / 91 1/3"
rear panel, length 100 cm / 39 1/3", height 45 cm / 17 3/4"
shelf, depth 36 cm / 14", length 100 cm / 39 1/3"
base shelf, depth 57 cm / 22 1/2", length 100 cm / 39 1/3"

prices on request

Legal Note

Responsible

walther design GmbH & Co. KG
www.waltherdesign.de

Product Photography

Tobias Kemper
walther design GmbH & Co. KG
Markus Faahsen
www.faahsen.de
Stefan Völker
www.voelkerphotography.net

POS & campaign presenter



metal presentation trolley
3 sides closed, for frames
lockable heavy duty rollers, not equipped



metal presentation trolley, equipped

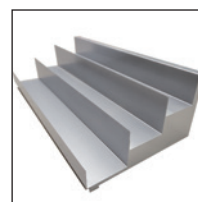

stage essay
with 3 levels



stage essay
U form for large sizes

article no.	description	width	depth	height	unit*
AS-750	metal presentation trolley	120 cm / 47 1/4"	70 cm / 27 1/2"	100 cm / 39 1/2"	1
AS-750-A	stage employment with 2 levels	122 cm / 48"	23 cm / 9"	26 cm / 10 1/4"	1
AS-750-B	stage essay with 3 levels	104 cm / 41"	28 cm / 11"	48,5 cm / 19"	1
AS-750-U	stage essay in U form for large sizes	50 cm / 19 3/4"	62 cm / 24 1/2"	40 cm / 15 3/4"	1

* not equipped



wooden promotion pyramid
equipped in 2 levels
colour different from picture



wooden promotion pyramid
equipped in 3 levels
frame sizes from 9 x 13 cm / 3 1/2" x 5"
up to 30 x 40 cm / 11 3/4" x 15 3/4"



promotion pallet
euro pallet remodeled with wood,
variable divider bars, depending
on the product presentation
easy transport due to removable side panels

article no.	description	width	depth	height	unit*
VD-101-B	wooden promotion pyramid, equipped in 2 levels, anthracite	120 cm / 47 1/4"	120 cm / 47 1/4"	115 cm / 45 1/2"	1
VD-102	wooden promotion pyramid, equipped in 3 levels, white	105 cm / 41 1/2"	78 cm / 30 3/4"	107 cm / 42"	1
VD-110-1	promotion pallet, incl. 6 divider bars, nature	120 cm / 47 1/4"	80 cm / 31 1/2"	28 cm / 11"	1
VD-110-3	promotion pallet, incl. 6 divider bars, anthracite	120 cm / 47 1/4"	80 cm / 31 1/2"	28 cm / 11"	1

* not equipped

POS & campaign presenter



multi-level display for frames/gallery frames
highest quality of cardboard
on ¼ euro pallet

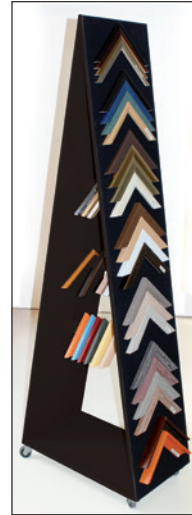

wooden stand for angle sets
black
with 3 crossbars

article no.	description	width	depth	height	unit*
VD-180	multi-level display for frames, 3 levels + base, on ¼ pallet incl. flexible tray braces and individually designable topper	60 cm / 23 ½"	40 cm / 15 ¾"	171 cm / 67 ½"	1
VD-125	display for gallery frames, on ¼ pallet	60 cm / 23 ½"	40 cm / 15 ¾"	80 cm / 31 ½"	1
MARMM-99	wooden stand for angle sets, surface covered with felt, 3 crossbars as additional storage space, 4 castors (2 lockable)	60 cm / 23 ½"	35 cm / 13 ¾"	174 cm / 68 ½"	1

* not equipped



counter display with aluminium frames
highest quality of cardboard
example 1



counter display with portrait frames
highest quality of cardboard
example 2



counter display with art supplies
highest quality of cardboard
example 3

article no.	description	width	depth	height	unit
VD-113	counter display VD-113 from highest quality of cardboard, not equipped	51 cm / 20"	28 cm / 11"	29 cm / 11 ½"	1
example 1	equipped with 37 aluminium frames „Chair“ in sizes 10 x 15 cm / 4" x 6", 13 x 18 cm / 5" x 7", 15 x 20 cm / 6" x 8" and 20 x 30 cm / 8" x 11 ¾" = AJ037M				
example 2	equipped with 42 portrait frames „Chloe“ in sizes 10 x 15 cm / 4" x 6", 13 x 18 cm / 5" x 7", 15 x 20 cm / 6" x 8" = BF042M				
example 3	equipped with art supplies consisting of brush set, oil and acrylic paints + water colours in a set of 12, 11 acrylic paints à 75 ml, 2 different structure pastes, painting cardboard in format 13 x 18 cm / 5" x 7" and 18 x 24 cm / 7" x 9 ½", canvas in size 13 x 18 cm / 5" x 7" and 20 x 20 cm / 8" x 8" = DIS087M				

Further equipments for this counter display are available on request.

General Terms and Conditions of Business of walther design GmbH & Co. KG

1. Scope

The following General Terms and Conditions apply to all orders, including those placed through our online shop www.waltherdesign.de by companies.

The following apply to companies: If the company uses contrary or supplementary General Terms and Conditions, then we hereby object to their applicability; they will only be considered a part of the contract if we have expressly agreed to this.

2. Contractual partner, conclusion of the contract

The purchasing agreement shall be concluded with walther design GmbH & Co. KG (hereinafter referred to as "walther design").

By placing the products in the online shop or our sales documents, we provide a binding offer to conclude a contract regarding these products. If you place our products in your shopping basket, this is non-binding; you can correct your entries at any time before submitting your binding order using the corrective tools provided for this purpose and explained during the ordering process. The contract will come into being when you click the order button to accept the offer for the goods contained in the shopping basket. Directly after you send the order, you will receive a confirmation via e-mail.

Orders by a company can also be placed in writing or by telephone.

walther design accepts the contractual offer of the customer by sending the ordered goods to the customer. The contract between walther design and the customer only comes into force upon shipment of the goods. If individual products in the order are not shipped by walther design, then no purchasing agreement shall come into force between the parties regarding these products.

walther design will send a written invoice and order confirmation to the customer along with the goods, which will list the amount to be paid by the customer, any VAT, and all other necessary information.

The customer cannot derive any claims from the fact that walther design may not have certain products in stock at a specific time, and is therefore not able to ship them.

3. Contractual language, saving the contract text

Contracts are concluded in German.

We save the contract text and send you the order data and our General Terms and Conditions in text form. You can review the contract text in our customer login on our website.

4. Delivery conditions

Shipping costs may be charged in addition to the indicated product prices. Further provisions on any shipping costs charged will be provided with the offers.

walther design is entitled to divide orders into partial deliveries.

If it is not possible to complete delivery to the customer for reasons for which the customer is responsible (not received at the delivery address provided, despite prior notification of delivery), then the customer shall bear the costs of the failed delivery attempt.

If not otherwise expressly agreed between the parties, goods shall be delivered ex works by walther design to the address provided by the customer. walther design will pay the costs for packaging and shipping the goods above an order value of € 250.00 for customers in Germany. walther design will choose the shipping method and freight carrier, if applicable.

If not otherwise expressly agreed between the parties, above an order value of € 2,500.00, walther designs will complete deliveries to international customers in return for advance payment, ex works to the address provided by the customer.

The minimum order value is € 175.00 net. If walther design voluntarily accepts an order with a volume below the minimum order value or below the respective indicated minimum order quantity, then the customer shall pay for packaging and shipping costs as well as processing costs, unless otherwise agreed. An expense charge of € 9.50 per order will be collected for this purpose.

5. Payment

In general, the following payment method is available to companies in our B2B shop or for telephone or written orders:

Invoice

Amounts invoiced by walther design must be paid by the customer within a 30-day payment term.

walther design shall grant a 2% discount if the invoiced amount is paid by the customer in cash within the first 14 days after the invoice date. walther design shall grant a 3% discount if the invoiced amount is paid via bank debit within the first 10 days after the invoice date.

walther design will only accept bills of exchange by special agreement. The customer shall have no entitlement to use this payment method.

If the invoiced amount is not paid before the payment deadline, then the customer will fall into default. In this case, receivables of walther design shall be charged interest in accordance with the law.

Please only make transfers to the account indicated, and enter the correct memo to ensure that the payments are assigned properly.

If you choose to make a purchase on account, your data (in particular your name and contact information) may be sent to Creditreform Boniversum GmbH, Hellersbergstrasse 11, 41460 Neuss for the purpose of a credit check. If this check does not return the desired results, for instance because the data cannot be clearly allocated, we will automatically offer you other available payment methods. Information in accordance with Art. 14 of the EU General Data Protection Regulation on data processing carried out by Creditreform Boniversum GmbH is available here: www.boniversum.de/EU-DSGVO

General Terms and Conditions of Business of walther design GmbH & Co. KG

In case of a return, the applicable amount will be credited to the bank account from which you completed the transfer.

6. Right of revocation

Companies are not granted any voluntary right of revocation.

7. Retention of ownership

Goods shall remain our property until full payment is received.

The following also applies to companies: We reserve ownership of the goods until all claims resulting from an ongoing business relationship are satisfied. You may sell the reserved goods in the course of normal business operations; all receivables resulting from this sale shall be assigned to us - regardless of whether the reserved goods are combined or mixed with any new products - in advance in the invoiced amount, and we hereby accept this assignment. You remain entitled to collect the claims from your customers; however, we may also collect claims ourselves if you do not fulfil your payment obligations.

8. Damage in transit

The following applies to companies: The risk of accidental destruction and deterioration shall be transferred to you once we have delivered goods to the shipping company, the freight forwarder, or the other person or entity which will handle the shipment.

The examination and complaint obligations regulated in Sec. 377 HGB (German Commercial Code) apply between merchants. If you do not submit the notification regulated there, then the goods will be considered accepted, unless the defect could not be discovered during the examination. This shall not apply if we have intentionally concealed a defect.

9. Defects, warranties and guarantees

Statutory defect liability applies.

Our information regarding the object of the delivery or service (such as weights, dimensions, consumption values, load-bearing capacities, tolerances, and technical data) as well as our illustrations of the same (such as drawings and images) are only approximate, unless usability for the contractually intended purpose requires that they be exact. These should not be considered guaranteed characteristics, but rather descriptions or designations of the delivery or service. Deviations customary in the course of business, or deviations due to legal regulations or that represent technical improvements, as well as replacing components with equivalent parts, are permitted if they do not negatively impact usability for the contractually intended purpose.

Companies must notify the company within 2 (two) weeks from receipt of the goods of any obvious defects, either in written form or text form; otherwise, no warranty claims may be asserted. Sending the defect notification promptly will fulfil this deadline. In the case of companies, we will fulfil the warranty for the defective goods initially by completing a repair or replacement delivery, at our discretion.

If delivered items have obvious material or manufacturing defects, including any damage in transit, we request that you submit complaints regarding such faults to us immediately, or to the employee of the shipping provider which delivers the goods. However, if you fail to submit this complaint, this will have no consequences for your legal claims. At your discretion, the statutory claims for supplementary fulfilment, for correction of the defect / new delivery or - if the statutory requirements apply - further claims to reduction or rescission as well as to claims for damages apply to all defects in purchased goods which become apparent during the statutory warranty period, including reimbursement of damages in place of fulfilment and reimbursement of your wasted expenditures.

10. Liability

We will always be liable without restriction for claims resulting from damages caused by us, our statutory representatives, or our agents

- in case of injuries to life, body, or health
- for intentional or grossly negligent breaches of duty
- for warranty promises, if agreed, or
- if the scope of the Product Liability Act applies.

In case of violations of significant contractual obligations that must be fulfilled to make it possible to properly carry out the contract, and which the contractual partner should regularly expect to be fulfilled (cardinal obligations) due to slight negligence on our part, the part of our statutory representatives, or our agents, liability shall be limited to the damages foreseeable at the time the contract was concluded and that should typically be expected.

Any other claims for damages shall be excluded.

11. Dispute resolution

The European Commission provides a platform for online dispute resolution, which is available here. We are prepared to take part in extra-judicial dispute resolution proceedings before a consumer arbitration board. The General Consumer Arbitration Board of the Zentrums für Schlichtung e.V., Straßburger Straße 8, 77694 Kehl am Rhein, www.verbraucher-schlichter.de is the responsible body.

12. Final provisions

The law of the Federal Republic of Germany shall apply to contracts between walther design and the customer, excluding laws governing the international sale of movable goods.

If you are a merchant under the Commercial Code, a legal entity under public law, or a public law special fund, then the exclusive place of jurisdiction for all disputes arising from the contractual relationships between our company and yourself shall be our headquarters.

Version: January 2022 (Version 3.0)

walther design GmbH & Co. KG

Post Box 25 27 | 41312 Nettetal | Germany

Herrenpfad-Süd 26 | 41334 Nettetal | Germany

Hotline: + 49 2157 8186-0 · Fax: + 49 2157 8186-50

E-Mail: service@waltherdesign.de · Website: www.waltherdesign.de/en

